

MY BERNINA

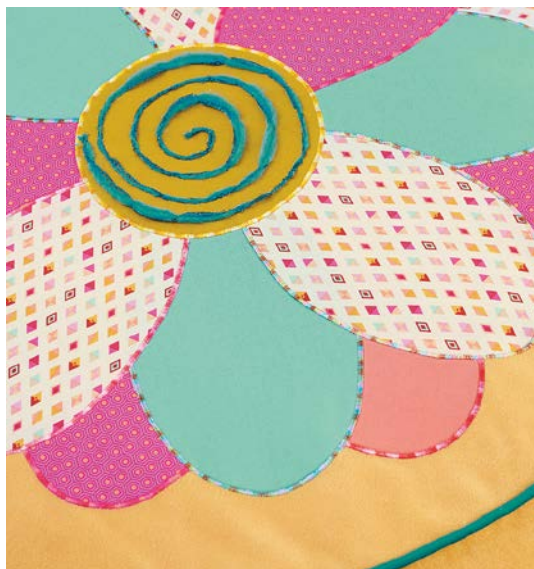

SEWING MACHINES

BERNINA SEWING MACHINE WORKBOOK

For BERNINA 880 PLUS, 790 PLUS, 770 QE, 740
BERNINA 590, 570 QE, 535, 480, 475 QE, 435



made to create

BERNINA

TABLE OF CONTENTS

TABLE OF CONTENTS.....	2	SAVING STITCHES IN PERSONAL PROGRAM ...	21
TABLE OF CONTENTS.....	3	TRIPLE STRAIGHT STITCH	22
INTRODUCTION	4	VARI-OVERLOCK STITCH	23
PREPARING TO STITCH	5	LONG STITCH	24
PERSONALIZE THE SCREEN	6	BLIND HEM	25
ACTIVATE/DEACTIVATE BEGINNING TIE OFF....	6	STRETCH STITCH	26
PROGRAM THREAD CUTTER AND SECURING STITCHES.	6	BALANCE.....	27
BREADCRUMBS.....	7	AUTOMATIC BUTTONHOLE PROGRAM ..	28
PROGRAM PATTERN END.....	7	MEMORY BUTTONHOLES	29
PROGRAM NEEDLE STOP DOWN AND HOVER ..	8	MANUAL BUTTONHOLES.....	30
PROGRAM THE FOOT CONTROL	8	ATTACHING BUTTONS.....	31
STITCH SELECTION.....	9	CREATIVE CONSULTANT-ZIPPER INFORMATION..	32
PRESSER FOOT RECOGNITION	10	COMBI MODE-STITCH PATTERNS.....	33
SECURITY PROGRAM-NEEDLE	11	COMBI MODE-LETTERING.....	34
SECURITY PROGRAM-STITCH PLATE SELECTION..	11	FREE-MOTION STITCHING	35
THE 'i' MENU	12	BERNINA STITCH REGULATOR #42	36
NEEDLE STOP UP/DOWN-FREE HAND SYSTEM	13	BERNINA STITCH REGULATOR PRACTICE	37
SECURING STITCHES	14	SIDEWAYS MOTION PATTERNS.....	38
PERMANENT REVERSE/BACKSTEPPING ...	15	MULTI-DIRECTIONAL STITCHING	39
MIRROR IMAGE/PATTERN REPEAT.....	16	MULTI-DIRECTIONAL STITCHES.....	40
PATTERN FUNCTIONS - PATTERN BEGIN/END.	17	CONNECTING STITCHES.....	41
PATTERN FUNCTIONS-PATTERN REPEAT/ ELONGATION	18	CONNECTING STITCHES AND MOVE MULTIPLES .	42
ALTERED STITCHES	19	ALL-OVER DIRECTIONAL STITCHING	43
TEMPORARY ALTERED MEMORY	20	STITCH DESIGNER OVERVIEW.....	44
PERMANENTLY ALTERED STITCH MEMORY..	20	STITCH DESIGNER	45
		STITCH DESIGNER	46

TABLE OF CONTENTS

STITCH DESIGNER 47

SAVING A STITCH DESIGNER STITCH TO A
USB STICK..... 48

IMPORTED STITCHES FROM BERNINA
SOFTWARE..... 48

DISTORTION..... 49

REFERENCE - BERNINA PRESSER FEET 50

REFERENCE - SEWING MACHINE NEEDLES...51

REFERENCE - SEWING MACHINE NEEDLES...52

REFERENCE - THREADS..... 53

REFERENCE - DECORATIVE STITCHING 54

REFERENCE - CLEANING AND OILING 55

B 880 PLUS SEWING FUNCTIONS 56

B 790 PLUS SEWING FUNCTIONS 57

B 770 QE SEWING FUNCTIONS..... 58

B 740 SEWING FUNCTIONS 59

B 590 SEWING FUNCTIONS 60

B 570 QE SEWING FUNCTIONS..... 61

B 535 SEWING FUNCTIONS 62

B 480 SEWING FUNCTIONS 63

B 475 QE SEWING FUNCTIONS..... 64

B 435 SEWING FUNCTIONS 65

The information in this workbook applies to the BERNINA Sewing Machines models shown here.

NOTE: Some exercises apply only to certain models equipped with the feature being highlighted.



INTRODUCTION

Welcome! Learning to use your new machine to its fullest capabilities will let you enjoy your machine for many years. Understanding your machine's features and learning its navigation will maximize your creativity. While you will be learning some basics, you'll also be learning some creative techniques, and we hope both will be inspirational.

Along with your machine's manual, this workbook is designed to take you on a step by step journey into your machine's capabilities. Once completed, the workbook can serve as a technique reference guide.

Stitched samples can be attached to the pages or inserted into sheet protectors, if desired. You will find additional resource materials in the back of this workbook

If you wish, you can stitch many of the sample techniques on one or two squares of prepared fabric and stabilizer (10" x 10" heavy muslin with a 10" x 10" piece of heavyweight tear away or cut away stabilizer behind it.) You will note the techniques that are suggested to be stitched on this fabric by the red classroom sampler logo. If there is no logo, then use the fabric suggested.

While this may be the beginning of your educational journey, there are other opportunities to grow creatively. BERNINA of America strives to provide quality sewing and embroidery machines while offering the best educational experience possible. Along with providing My BERNINA Classes, your local BERNINA dealer stocks BERNINA reference books, such as the Big Book of Feet.

Instructional video tutorials are available on bernina.com and the BERNINA YouTube channel. You will also find inspiring sewing projects and eBooks on the BERNINA website at bernina.com in the Experience Section.

www.bernina.com

www.weallsew.com



PREPARING TO STITCH

CLEANING AND OILING

Keeping your machine clean and well oiled will keep your machine running smoothly is a crucial component for successful machine stitching. Refer to Page 55 for cleaning tips. Your machine manual will also give you detailed cleaning and oiling suggestions.

STITCH PLATE

Attach the appropriate stitch plate.

- 5.5 mm Embroidery Stitch Plate: Standard accessory for B 535, 475 QE, 435
- 9 mm Stitch Plate: B 880 PLUS, 790 PLUS, 770 QE, 740, 590, 570 QE, 480

PRESSER FOOT

- Attach Reverse Pattern Foot #1/1C/1D or Shank/Sole #1 to the machine. (Refer to Page 54 Reference-Presser Foot for more information about BERNINA Presser Feet.)

RAISE FEED DOGS

When moving between embroidery and sewing, an animation will appear to remind you to do raise or lower the feed dogs on all machines with the exception of the B 880 PLUS. The feed dogs automatically raise or lower on the B 880 PLUS, but need to be manually raised on all other machines.

INSERT AND THREAD NEEDLE (Refer to Page 53 Reference-Threads for additional information.)

- Use the proper needle for the thread and fabric being used. It is advisable to insert a new needle for each project, or after every 4 to 6 hours of sewing time.
- Always thread with the presser foot up. This opens the tension discs and allows the thread to seat properly.

THREADING TIPS FOR MODELS WITH BOTH HORIZONTAL AND VERTICAL SPOOL PINS:

- Use the horizontal spool pin with cross-wound threads; match spool cap size to end of spool.
- The smallest spool cap fits into the end of large cones/spools such as Isacord embroidery thread.
- Use the vertical spool pin with stacked threads and for some decorative threads (metallic threads); use the foam disc under the spool to avoid extra tension on the thread.

THREAD THE BOBBIN FOR SEWING

- Generally, you will wind the bobbin with the same thread/thread weight that you will use in the needle.
- Insert the bobbin:
 - 7, 5, and 4 Series: Insert the bobbin into bobbin case and bobbin case onto the machine. The bobbin is threaded the same way for both embroidery and sewing.
 - B 880 PLUS: With the bobbin markings facing the front, place the bobbin into the hook and push until it clicks in place. Pull the thread to the right into the slit (1); then under the spring. Pull the thread over the thread cutter and cut (2).

NOTE: When going back and forth between sewing and embroidery on the B 880 PLUS, an animation will appear as a reminder to re-thread the bobbin case for sewing. This does not indicate an error in threading.

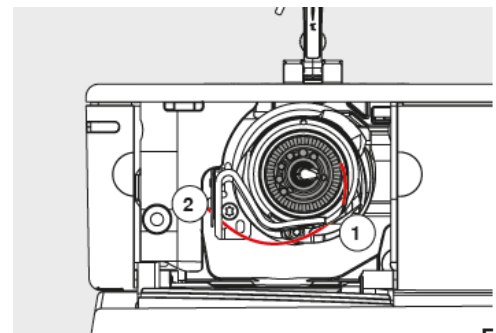

PERSONALIZE THE SCREEN

You can personalize the display and wallpaper color to suit your individual tastes. Change the color as well as the texture in the Setup Program. A welcome text can also be programmed.



1. Touch the Setup icon.
2. Select Personal Settings and a display appears.
3. Select the color and texture.
4. Close the screen (or use the setup breadcrumb to navigate back to Setup).

ACTIVATE/DEACTIVATE BEGINNING TIE OFF

B 880 PLUS, 790 PLUS, 770 QE, 740, 590, 570 QE, 535, 480, 475 QE Only

Activate or deactivate the securing stitches at the beginning of every stitch/stitch type. If activated, the securing stitches are sewn when either the Thread Cutter or the Threader have been used.

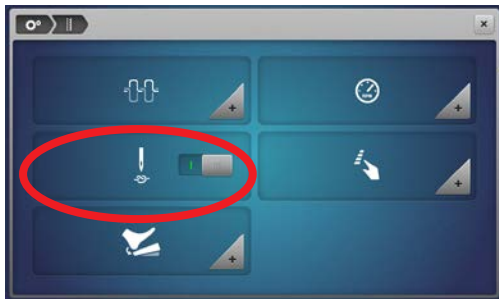

1. Select Setup.
2. Select Sewing Settings.
3. The slider next to the Securing Stitches at Pattern Begin will activate or deactivate the tie off at the beginning of the stitch. (This is a switch for on/off.)
4. Toggle the switch to off.
5. Close the screen (or use the setup breadcrumb to navigate back to Setup).

PROGRAM THREAD CUTTER AND SECURING STITCHES

B 880 PLUS, 790 PLUS, 770 QE, 740, 590, 570 QE, 535, 480, Only

The number and type of the securing stitches the machine makes after the Thread Cutter has been engaged can be programmed in a number of ways.



1. Select Setup.
2. Select Sewing Settings.
3. Select Programmable Buttons.
4. Select the Automatic Thread Cutter and Securing Stitches (scissors) icon.
5. Reprogram as desired per project.
6. Leave this screen open and proceed to the next page.

BREADCRUMBS

Learn to navigate within menus using the breadcrumb icons rather than using the Close box to exit. This is a time-saving feature when setting preferences within several menus in Setup, embroidery motif selection, and the "i" menu in sewing and embroidery.

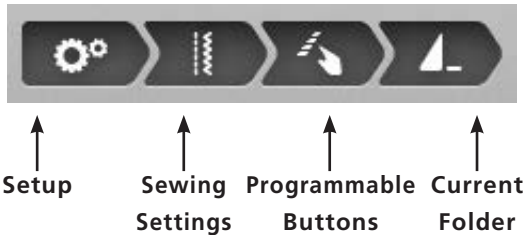

1. Note the breadcrumb trail at the top of the screen.
2. Touching any of the icons in the breadcrumb will take you back to that particular menu. This is a time saver when changing multiple settings within a menu.

PROGRAM PATTERN END

B 880 PLUS, 790 PLUS, 770 QE, 740, 590, 570 QE, Only

The number and type of securing stitches when using the external Pattern End/Securing Button can be programmed. This button can also be programmed so the machine will cut the thread and/or lift the presser foot when the Pattern End Button is engaged.

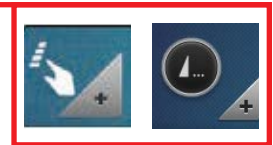

1. Using the breadcrumb, select Programmable Buttons.
2. Select the Securing Program icon.
3. Pattern End can be re-programmed to do the following functions after Pattern End is engaged:
 - Standard (4 securing stitches sewn in place).
 - Small stitches sewn in a forward direction (can be programmed to take between three and six stitches).
 - Upper and lower thread automatically cut.
 - Presser foot automatically raised.
4. To use pattern end as only Pattern End, deactivate the knot and cutter.

Sew HOW

Do you know how to:

- Use the breadcrumbs to navigate?
- Program Pattern end?

PROGRAM NEEDLE STOP DOWN AND HOVER

B 880 PLUS, 790 PLUS, 770 QE, 740, 590, 570 QE Only

Take advantage of Hover when stitching with Needle Stop Down engaged. When the stitching stops with Needle Stop Down engaged, the machine can be programmed to stop with the presser foot down or to hover.

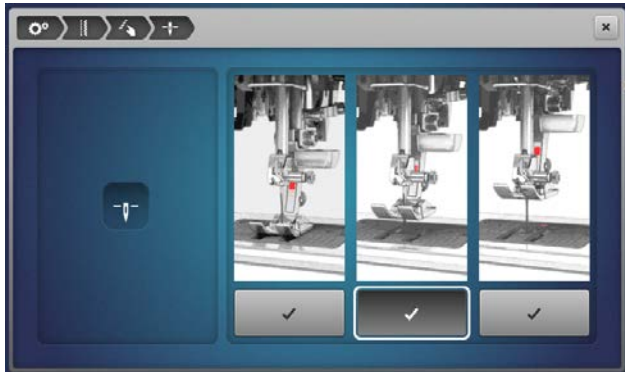

1. Using the breadcrumbs, select Programmable Buttons.
2. Select the Needle Stop Down icon.
3. Select the middle option from the three choices:
 - Presser foot remains down when the machine stops.
 - Presser foot hovers enough to pivot the fabric.
 - Presser foot is raised into its highest position.

PROGRAM THE FOOT CONTROL

B 880 PLUS, 790 PLUS, 770 QE, 740, 590, 570 QE, 480 Only

The Foot Control can be programmed with desired settings. The Foot Control default setting is to raise or lower the needle when the heel of the foot control is depressed. The Programmable Foot Control back kick options also allow the heel-down to signal a tie-off and/or cut the thread instead.



1. Using the breadcrumbs, navigate back to the Setup menu; select Sewing Settings.
2. Select the Foot Control icon.
3. If the Needle icon is selected, the back kick will move the needle to the next position.
4. Select the Heart icon. The back kick can be programmed in a number of ways:
 - When the Securing icon is selected, the number and type of securing stitches can be programmed for two to six securing stitches in place, or for two to six securing stitches forward. The standard for both is 4 stitches.
 - When the Automatic Thread Cutter icon is selected, the upper and lower threads are cut automatically by the back kick.
 - When the Presser Foot Lift icon is selected, the presser foot is raised by the back kick.
5. For the class exercises, program the Foot Control to raise or lower the needle.
6. Exit the Setup menu.

STITCH SELECTION

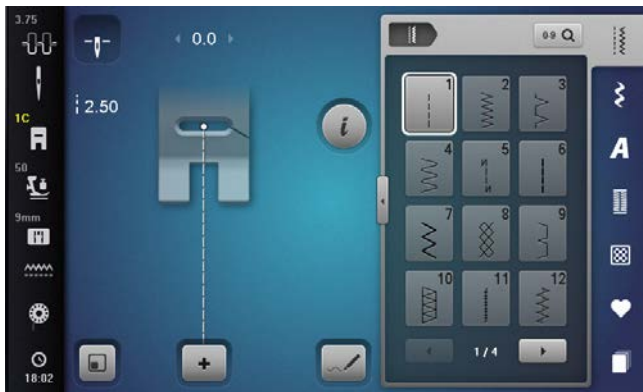

Selecting a Stitch

1. Select stitches by touch selection, or by using the Search by Number function. Use your finger or the stylus that came with the machine to access buttons on the screen. (See note below for 4/5 Series stylus information.)
2. Stitches are grouped into categories with some categories having multiple folders for selection.
3. Many categories have more than one screen.
 - Use the arrows at the bottom of the screen to move forward and back in the stitch category.
 - 4 and 5 Series machines: slide to scroll vertically through stitch selection menus.



Transitions

1. View more stitches on screen by using the Transition. Select to view all folders or to see more stitches at one time.
2. Select Folder 101. Touch the Transition arrow to view the stitches in the category.
3. Some categories will have more than one screen. Use the arrows at the bottom of the screen or scroll to move forward or backward.
4. Touch the Transition icon to close the screen.

NOTE: The new 4 and 5 Series machines have a capacitive touch screen. These touch screens respond to a special capacitive stylus or your fingertip. Standard styluses, such as those supplied with the 7 or 8 Series machines will not work on this type of screen.

PRESSER FOOT RECOGNITION

B 880 PLUS, 790 PLUS, 590, 570 QE

Presser Foot Selection applies limitations and security with the use of certain feet in embroidery and sewing. For example, programming the machine that the zipper foot is attached prevents the needle from striking the foot. However, it is not *required* to set the Presser Foot Selection to be able to sew.



1. Select the Straight Stitch.
2. Select the Presser Foot Selection icon from the Status Bar.
3. Select Zipper Foot #4 by finding the foot on the screen. You can also use the Search icon and type 4 using the keypad. Notice that the programmed foot is reflected on the status bar in yellow.
4. Close the Presser Foot Selection menu.
5. The Straight Stitch is displayed in red indicating that the straight stitch would strike the foot. If you have this feature set and attempt to stitch, you will get a message indicating that the needle will strike the foot.
6. Use the Needle Position Button to adjust the needle to the left or the right. When the stitch becomes white, it is safe to sew.
7. To clear Presser Foot Selection, touch the Presser Foot Selection on the Status Bar and either select the programmed foot or press CLR on the System Settings Bar. Close the Presser Foot Selection screen.
8. To return the needle to the center position, touch CLR again.



For more information on BERNINA Presser Feet, refer to Reference-BERNINA Presser Feet on Page 50.

Notes:

- The Gold Star tabs indicate a recommended accessory for the stitch that is currently selected.
- The Presser Foot Selection feature on the B 770 QE, 740, 480, 475 QE and 435 gives suggested feet for certain stitches, but this is for informational purposes only. It does not limit the stitch properties.

SECURITY PROGRAM-NEEDLE

Setting the Needle Security Program can be very helpful in sewing. It can prevent needle breakage and damage to your machine or presser foot. The function remains active even when the machine is turned off and on.



For more information on needles, refer to Reference-Sewing Machine Needles on Pages 51 and 52.

1. Touch the Needle Selection icon. A display will appear.
2. Select the Standard Needle.

Needle Minder: Store the needle size and type of the needle selected.

Specialty Needles: When selecting a specialty needle (such as a double needle) the stitch width is limited automatically. This prevents the inserted specialty needle from hitting the presser foot or the stitch plate. This setting will remain active even after the machine is turned off.

Sew HOW

Do you know:

- On some models, Creative Consultant recommends the needle according to the fabric and technique.



SECURITY PROGRAM-STITCH PLATE SELECTION

Setting the Stitch Plate Security Program can be very helpful in sewing. If an inappropriate needle or stitch is selected, the machine will limit the width of any stitch to prevent needle breakage. The function remains active even when the machine is turned off and on.

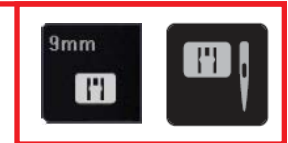

1. Touch the Stitch Plate Selection icon.
2. Select the 9 mm Stitch Plate (5.5 mm for the B 535) so that decorative stitches can be stitched at their maximum width.

0 mm or 0 mm/Cut Plate: This plate is used for embroidery. Make sure that the machine stitch plate has been changed before programming another plate. Many quilters prefer to use this stitch plate when piecing.

Punch Plate: This plate is used when doing Punchwork on either the sewing or embroidery side of the 9 mm machines.

THE 'i' MENU

All creative functions that can be applied to a stitch are accessed through the Information menu, "i".



Reverse Backstepping Save
Stitch
Setting
Permanently Reset
Stitch to
Factory
Setting

1. Select Stitch #401.
2. Touch the "i" to access the Information screen.
 - Only icons relevant to the selected stitch are visible.
 - A different set of icons is available for decorative stitches, tapering, BSR (BERNINA Stitch Regulator), and buttonhole.
 - When partial icons are shown in the "i" menu, use your fingertip or stylus to vertically scroll and access the remaining icons.
 - Permanent icons are separated by a line, they do not move during scrolling and are always visible.
 - The permanent icons are Continuous Reverse, Backstepping*, Save Stitch Setting Permanently**, and Reset Stitch to Factory Setting**.
 - When making multiple alterations within the "i" menu, use breadcrumb navigation to stay within the "i" menu until all the changes have been set before closing.
 - Use the "i" breadcrumb to go back one level.
3. Touch the stitch number breadcrumb. It will take you back to the stitch selection menu.





NOTE:

*The B 480 and B 475 QE do not have Backstepping as an option in the Information menu. However, the Quick Reverse can be programmed in Setup as Backstepping. Then touch the Quick Reverse icon to activate the permanent reverse sewing (Backstepping).

*Backstepping is not an option on the B 435.

**The B 435 does not have the Save Stitch Setting Permanently/Reset Stitch to Factory Setting functions.

NEEDLE STOP UP/DOWN-FREE HAND SYSTEM

-  Firm woven fabric, 4" x 6", two pieces*
-  80/12 Universal
-  Polyester or cotton embroidery thread
-  Center
-  Reverse Pattern Foot #1/1C/1D, Sole #1

*or use Classroom Sampler Fabric

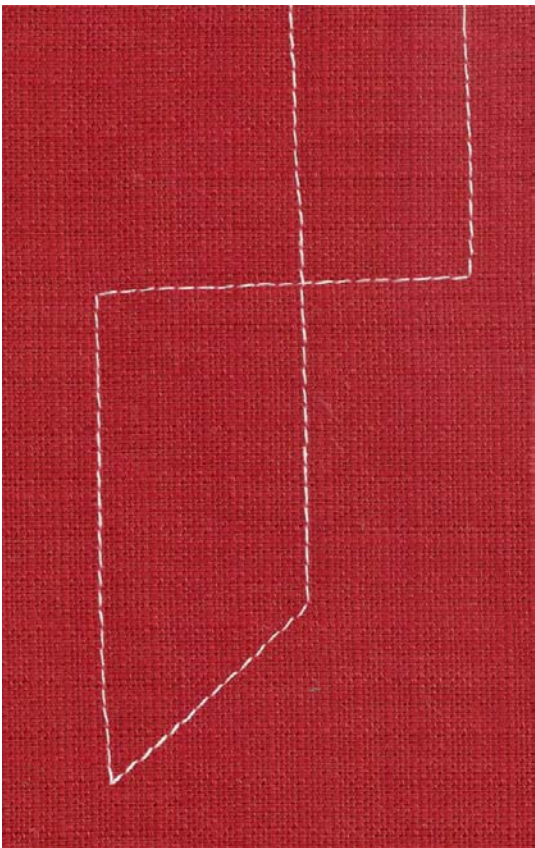
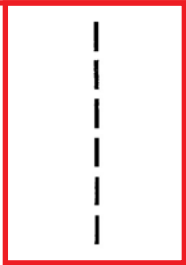

1. Select the Straight Stitch #1.
2. Touch the Needle Up/Down Button on the machine. Each push of the button will raise or lower the needle.
3. To program the needle to stop in the down position, select the Needle Stop Up/Down icon on the screen.
 - This setting remains until changed, even if the machine is turned off.
4. Sew a line of stitching and stop in the middle of the fabric. Hover is turned on by default and the foot will raise 2.0 mm when the machine stops.

NOTE: *Hover can be programmed from 0 mm (not raised at all) to 7 mm in height for those machines with that function.*
5. Pivot to form at least 2 right angle corners and 2 additional corners.
 - When pivoting, use the FHS (Free Hand System), to raise the presser foot. **NOTE:** *The Free Hand System Lever is an optional accessory for the B 435.*



How do I lower the presser foot for sewing?





- With the exception of the B 535, 480, 475 QE, and 435, there is no presser foot lift in the back of the machine--use the button on the front of the machine to raise/lower the presser foot.
- Press the Foot Control to lower the foot and begin sewing.
- Press/tap the Start/Stop button to Hover and re-position your work.

Sew HOW

Do you know how to:

- Use the Free Hand System?
- Use the back kick on the foot control to move the needle up or down?

SECURING STITCHES

-  Firm fabric, 4" x 6", three pieces; fold in half lengthwise to 2" x 6"*
-  80/12 Universal
-  Polyester or cotton embroidery thread
-  Center
-  Reverse Pattern Foot #1/1C/1D, Sole #1
Optional: Quilting Seam Guide or Seam Guide with Ruler

*or use Classroom Sampler Fabric

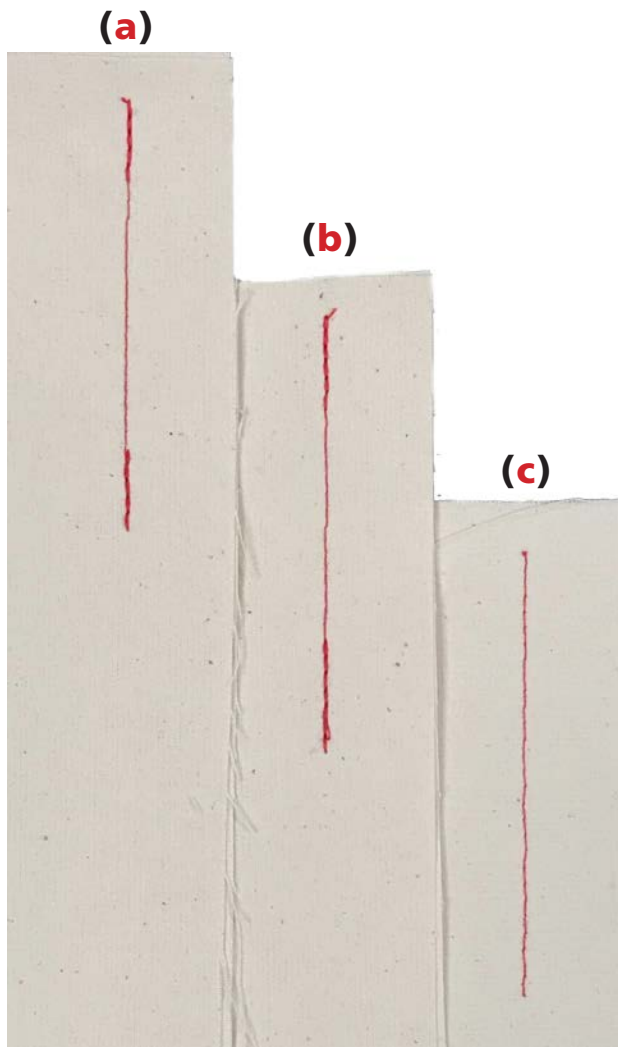
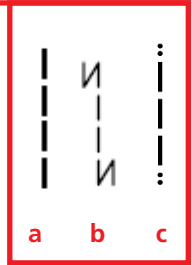

Straight Stitch/Reverse (a)

1. Place one fabric piece under the presser foot, aligning the 6" cut edge with the 5/8" guide line on the stitch plate.
2. Select the straight stitch. Sew a few stitches forward, then press and hold the Quick Reverse Button on the machine as you sew a few stitches backward; the machine will sew in reverse until the Quick Reverse Button is released.
3. Continue stitching the seam; secure the end in the same way.

Securing Program (b)

1. Select the Securing Program #5 (b). Begin to sew on 2nd piece of fabric; machine will automatically take five straight stitches forward and back at the beginning to secure the stitching.
2. At the end of the seam, press and release the Quick Reverse button. The machine will automatically take five stitches backward, five stitches forward to secure the stitching, and then stop.

Quilter's Securing Program (c)







1. Select the Quilter's Securing Program (#1324 for 7/8 Series/#1301 for 4/5 Series (c). Begin to sew on 3rd piece of fabric; the machine will take 6 short stitches forward at the beginning to secure stitching, then continue stitching forward.
2. At the end of the seam, press and release the Quick Reverse button. The machine will take 6 short stitches forward to secure and then stop.

Sew HOW

Do you know how to:

- Activate the Securing Function at the beginning and end of a stitching pattern?

PERMANENT REVERSE/BACKSTEPPING

-  Firm woven fabric, 4" x 6"
-  Lightweight tear-away stabilizer 4" x 6"
-  80/12 Universal
-  Polyester or cotton embroidery thread
-  Default
-  Reverse Pattern Foot #1/1C/1D, Sole #1 or Clear Foot #34/34C/34D

*or use Classroom Sampler Fabric

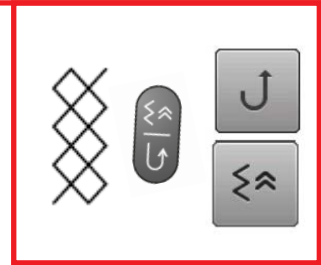

NOTE:

- Backstepping is not an option for the B 435
- The B 480 and B 475 QE do not have Backstepping as an option in the Information menu. However, the Quick Reverse can be programmed in Setup as Backstepping; touch the Quick Reverse icon to activate permanent reverse sewing (Backstepping).
- The Quick Reverse button on the machine can be programmed in the setup menu to operate as Quick Reverse or Backstepping.

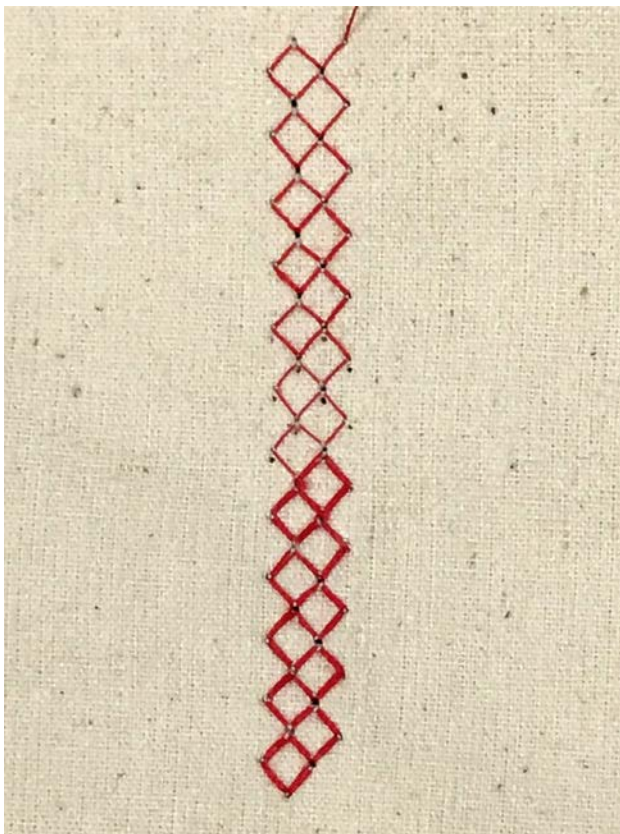

Permanent (Continuous) Reverse sews the selected stitch pattern in reverse.

Backstepping is more precise, as it will retrace the last 200 needle penetrations to give accurate stitch-by-stitch reverse sewing.

This feature is great when you have a thread break or unknowingly run out of bobbin thread. You can re-thread and backstep to the exact location of the last sewn stitch.







1. Place the stabilizer behind the fabric.
2. Select the Honeycomb Stitch #8. Engage the Needle Stop Down function.
3. Stitch about two inches on the fabric and stop with the needle down; do not move the fabric.
4. Select the "i" menu. Select Permanent/Continuous Reverse or Backstepping:
 - Permanent Reverse can be accessed with the button on the machine, or select "i"; Permanent Reverse Sewing.
 - Backstepping can be accessed by selecting "i"; Backstepping.
5. Continue stitching; the machine will now stitch backward, forming the stitches precisely on top of the previous ones. While the machine is stitching, engage the Pattern End function; the machine will stop at the end of the pattern.
6. Clip threads. Select the Backstepping icon again to disengage the function.

Sew HOW

Do you know how to:

- Sew backward on your model?

MIRROR IMAGE/PATTERN REPEAT

-  Firm woven fabric, 4" x 6"*
-  Lightweight tear-away stabilizer 4" x 6"*
-  80/12 Universal
-  Polyester or cotton embroidery thread
-  Default
-  Open Embroidery Foot #20/20C/20D, Sole #20

*or use Classroom Sampler Fabric



1. Attach Open Embroidery Foot #20/20C/20D.
2. Place stabilizer behind fabric.

Left/Right Mirror Image:

1. Select the Blanket Stitch #1329 for 7/8 Series/#1309 for 4 and 5 Series from the Quilting Stitch menu.
2. Sew one row down length of fabric.
3. Engage Left/Right Mirror Image and sew a second row next to the first, using the side of the presser foot for spacing.

Pattern Repeat:

1. Select the satin stitch arrowheads stitch #401.
2. Select the "i". Change Pattern Repeat to 4x.

Up/Down Mirror Image:

1. Stitch one stitch pattern for a total of 4 arrowheads. The machine will stop when the stitch pattern is complete.

Tip: To make sure you have a complete pattern, depress the foot control and do not lift your foot until the machine stops.
2. Engage Up/Down Mirror Image. The entire stitch pattern of four arrowheads will be mirror imaged.
3. Stitch one stitch pattern for a total of four arrowheads.
4. If desired, repeat the previous two steps to stitch four complete sets of arrowheads.

Horizontal Mirror Image (Left/Right):

- Machine sews selected stitch in Horizontal Mirror Image
- Right/left is determined by the sewing direction.

Vertical Mirror Image (Up/Down):

- Machine sews selected stitch in Vertical Mirror Image
- Up/down is determined by the sewing direction.

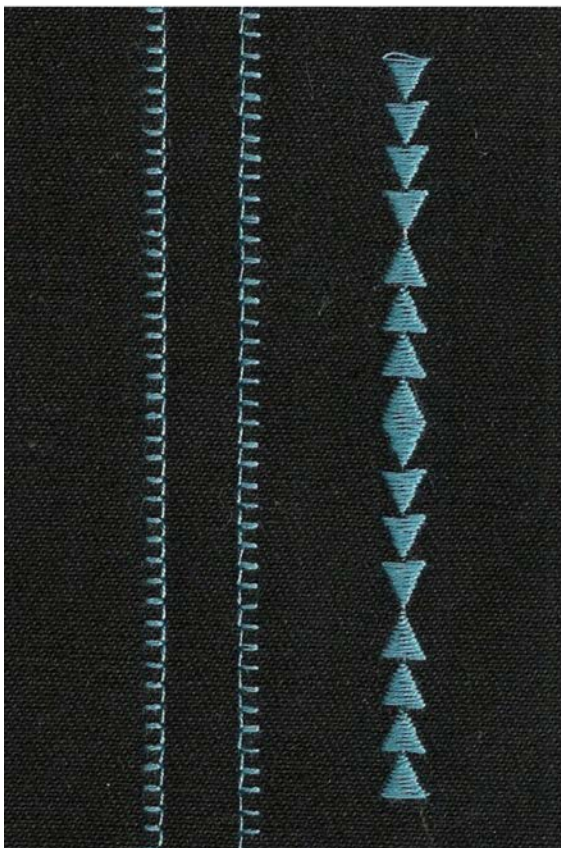







Sew HOW

Do you know how to:

- Tell the difference between Left/Right and Up/Down Mirror Image functions?
- Engage Pattern Repeat?

PATTERN FUNCTIONS - PATTERN BEGIN/END

-  Firm woven fabric, 4" x 6"*
-  Lightweight tear-away stabilizer 4" x 6"*
-  80/12 Universal
-  Polyester or cotton embroidery thread
-  Default
-  Open Embroidery Foot #20/20C/20D, Sole #20

*or use
Classroom
Sampler Fabric

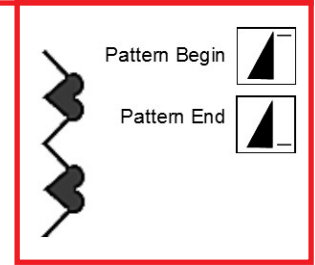

NOTE: Refer to Page 54 Reference-Decorative Stitching for more tips on appropriate tools for decorative stitching.

1. Attach Open Embroidery Foot #20/20C/20D. Select the appropriate foot in Presser Foot Selection/Display.
2. Place the stabilizer behind the fabric.
3. Select the satin stitch hearts stitch #413.
4. Sew 2½ patterns, stopping in the middle of the third pattern.
5. Lift the presser foot and move the needle down about an inch; then begin sewing again. The pattern will start forming where you left off.
6. After completing the interrupted heart, start the final heart and press Pattern End. The machine will stop stitching when the pattern is complete.

Tip: To make sure you have a complete pattern, depress the foot control and do not lift your foot until the machine stops.

7. Move to a new position and sew 2½ patterns, stopping in the middle of the third pattern. Lift the presser foot and move the needle down about an inch.
8. Before starting to sew again, press Pattern Begin.

NOTE: On most models, the Pattern Begin icon appears on the screen in the stitch altering area only when the pattern is not at the beginning. To get to the beginning of the pattern, select the on-screen Pattern Begin icon. If it is not visible, then the needle is at the beginning of the stitch pattern. On the B 790 PLUS, touch the button to the left of the screen.



9. Start sewing; the pattern will start forming at the beginning. Again, press Pattern End when you start the final heart.

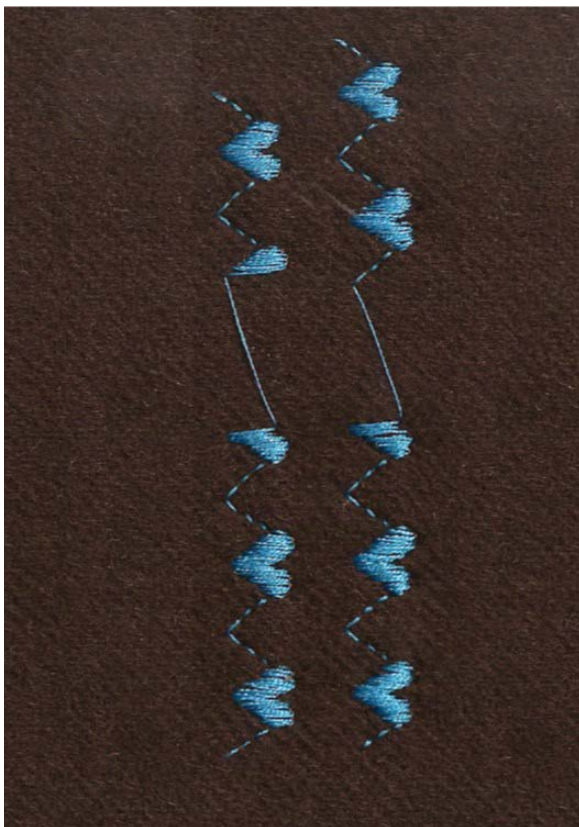







Sew HOW

Do you know how to:

- Recognize the difference between the icons for Pattern Begin and Pattern End and know where they are located?

PATTERN FUNCTIONS-PATTERN REPEAT/ELONGATION

-  Firm woven fabric, 4" x 6"*
-  Lightweight tear away stabilizer 4" x 6"
-  80/12 Universal
-  Polyester or cotton embroidery thread
-  Default
-  Open Embroidery Foot #20/20C/20D, Sole #20

*or use Classroom Sampler Fabric

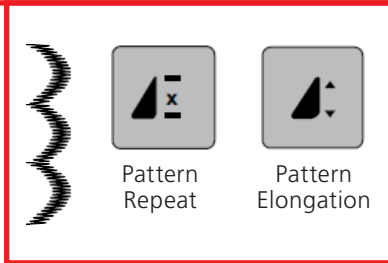

Notes:

- The *Stitch Density* of a stitch can also be increased or decreased by using the -/+ icons under *Stitch Density*. It can be changed in a decorative application to change the stitch as you prefer, and is most effective with satin stitches (Folder 401). *Stitch Density* is not available for every stitch. (Density adjustment is not available on the B 570 QE or the 4 Series machines.)
- *Elongation* allows you to increase or decrease the length of an entire stitch pattern to the size that you need. This feature is not available for every stitch.



Pattern Repeat 1-9x/1-99x

Program the B 880 PLUS, 7 Series, 535, and 4 Series machines to stop at the end of 1 - 9 repeats of a single stitch or stitch combination.

NOTE: The B 590 and B 570 QE can be programmed to stop at the end of 1 - 99 repeats.

1. Attach Open Embroidery Foot #20/20C/20D.
2. Place the stabilizer behind the fabric.
3. Select the satin stitch scallop pattern #416; Open the "i" menu and Pattern Repeat 1x.
4. Sew until the machine stops; you will have one scallop.
5. Increase Pattern Repeat to 3x. Sew until the machine stops; you will have one stitch pattern.

NOTE: In this case, one stitch pattern equals the repeated group of three scallops.

Pattern Elongation

NOTE: Not available on the B 535, 475 QE, or 435)







1. Change Pattern Repeat to 1x.
2. Set Pattern Extend to 300% using the slider icon (or the +). Pattern Extend can also be increased in 100% increments by touching the +100% icon.
3. Sew until the machine stops; you will have one stitch pattern.
 - In this case, one stitch pattern equals one extended scallop.
 - As the stitch pattern is elongated (lengthened), the stitch density is maintained.
4. Select the "i" breadcrumb to close the Pattern Extend screen and return to the "i" menu.

Sew HOW

Do you know how to:

- Recognize the two different pattern functions (which icon stands for each)?

ALTERED STITCHES

-  Firm woven fabric, 4" x 6"*
-  Lightweight tear-away stabilizer 4" x 6"*
-  80/12 Universal
-  Polyester or cotton embroidery thread
-  Default
-  Open Embroidery Foot #20/20C/20D, Sole #20

*or use
Classroom
Sampler Fabric

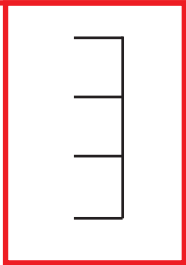

1. Attach Open Embroidery Foot #20/20C/20D.
2. Place the stabilizer behind the fabric.
3. Select Blanket Stitch #1329 for 7/8 Series/#1309 for the 4 and 5 Series from the Quilting Stitches menu.
4. Sew a row of stitches.
5. Adjust stitch width to 3.5 mm and stitch length to 4.1 mm. Sew a second row of stitching next to the first.
6. Touch the stitch length numeric value on screen. Tap the yellow highlighted box to revert the stitch length to the machine default stitch length setting. Leave the stitch width at 3.5 mm.
7. Sew a third row of stitching next to the previously sewn rows.
8. Leave this stitch on the screen and go to the next page.

Programmed settings	3.5 mm width 4.1 mm length	3.5 mm width Default length
------------------------	-------------------------------	--------------------------------

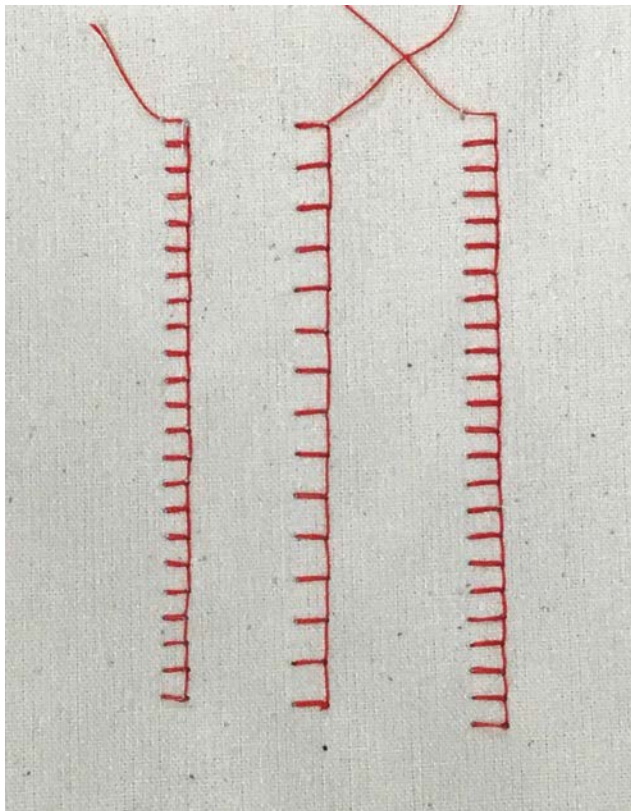

Sew HOW

Do you know how to:

- Find the Quilting Stitch menus on your model?
- Reset the stitch length and width to the preprogrammed settings?

TEMPORARY ALTERED MEMORY

Temporary Altered Memory is an exclusive feature of BERNINA sewing machines. The machine will remember the last stitch alterations made to any stitch. These alterations will remain in effect until manually changed, until CLR is touched, or until the power to the machine is turned off.



1. Using the stitch created on the previous page, notice that the stitch width has been changed. This is indicated by the yellow number.
2. Select Stitch #1.
3. Re-select Blanket Stitch #1329 for 7/8 Series/#1309 for 4/5 Series from the Quilting Stitches menu. Notice that the stitch has retained the altered settings.
4. Leave the width at the altered setting.

PERMANENTLY ALTERED STITCH MEMORY

B 880 PLUS, 790 PLUS, 770 QE, 740, 590, 570 QE, 535, 480, 475 QE Only

Changes can be made to any stitch and saved in the permanent memory of the machine. The machine will remember the altered stitch, even after the machine has been turned off. These alterations will remain in effect until manually changed with the Reset function.

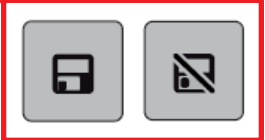

Permanently Altered Stitch

1. Select the Running Stitch; alter the stitch length to 1.0. Adjust the width as desired.
2. Select the "i" menu. Select the Save Stitch Setting Permanently icon.

The settings will remain in effect even after the machine is turned off. When the machine is turned back on and the stitch is selected, you will know that it was altered because of the yellow outline around the "i" icon.

Reset a Permanently Altered Stitch to Default Settings

1. Select the Running Stitch.
2. Touch the Reset Stitch to Factory Setting icon. The stitch has now been reset to the original settings.

HISTORY: B 880 PLUS, 790 PLUS

Sewn stitches along with any alterations are recorded in a History Menu. Stitches must be sewn to be recorded and are retained even after the machine is shut down. Stitches can be selected from the History Menu. History holds a maximum of 24 stitches.



Sew HOW

Do you know how to:

- Make stitch alterations?
- Clear the Temporary Altered Memory?

SAVING STITCHES IN PERSONAL PROGRAM

Use the Personal Program to store your favorite stitches, most often used stitches, or perhaps a group of stitches needed for a particular technique or project. There are four Personal Program folders.



Creating a Personal Program

1. Select the desired stitch. For this exercise, select the altered Blanket Stitch from previous page.
2. Close the "i" screen, if opened.
3. Touch Personal Program.
4. Select the Save Stitch icon.
5. Select one of the four Personal Program folders.
6. The selected stitch has a yellow border around it. Select the highlighted stitch to save, or select the green check box with the check to add the stitch to the Personal Program folder.
7. The display closes.

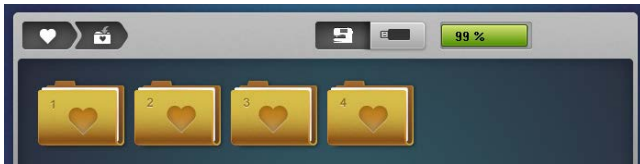

TRIPLE STRAIGHT STITCH

 Firm woven fabric, 4" x 6", two pieces

 80/12 Universal

 Polyester or cotton embroidery thread

 As directed in instructions

 Reverse Pattern Foot #1/1C/1D, Sole #1
 Edgestitch Foot #10/10C/10D
 (optional accessory)

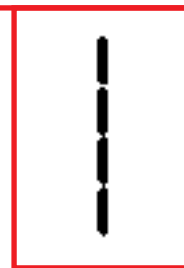

Notes:

The Triple Straight Stitch creates a very sturdy seam on items that will receive a lot of wear.

It also creates beautiful bold topstitching with regular weight thread that mimics the look of a heavier decorative topstitching thread.



Triple Straight Stitch Seam

1. Attach Reverse Pattern Foot #1/1C/1D to the machine.
2. Select the Triple Straight Stitch #6.
3. Place the fabric pieces right sides together.
4. Position the edge of the fabric along the 5/8" mark on the stitch plate.
5. Sew the seam and press it open.

Triple Straight Stitch Edgestitching





1. Change to Edgestitch Foot #10/10C/10D and adjust the needle position to the far right.
2. With the right side of the fabric up and with the guide of the foot in the ditch of the seam, sew the length of the seam from top to bottom.
3. Adjust the needle position to the far left.
4. Stitch a second time with guide of the foot in the ditch of the seam. Sew in the same direction as before.

Sew HOW

Do you know how to:

- Adjust the needle position?
- Use Edgestitch Foot #10/10C/10D?
- Use the triple stitch function on the B 590 and B 570 QE?

VARI-OVERLOCK STITCH

-  Cotton interlock, 4" x 6", two pieces
-  80/12 Universal
(Ballpoint or Stretch may also be used)
-  Polyester or cotton embroidery thread
-  As programmed
-  Overlock Foot #2/2A, Sole #2
(optional accessory for B 770 QE, 740)



1. Attach Overlock Foot #2/2A to the machine.
2. Select the Vari-Overlock Stitch #3.
3. Engage the Needle Stop Down function if available.
4. Guide the raw edges of the fabric under the pin of the foot and stitch the two layers together. The stitch will form over the pin and the edge of the fabric.

Notes:

Using the Overlock Foot and the Vari-Overlock Stitch will keep the edge of the fabric flat, not rolled.

Other stitches that work with this presser foot are the Stretch Overlock Stitch and the Double Overlock Stitch.

If your machine has Presser Foot Recognition (see Page 10 for details), select Foot #2.

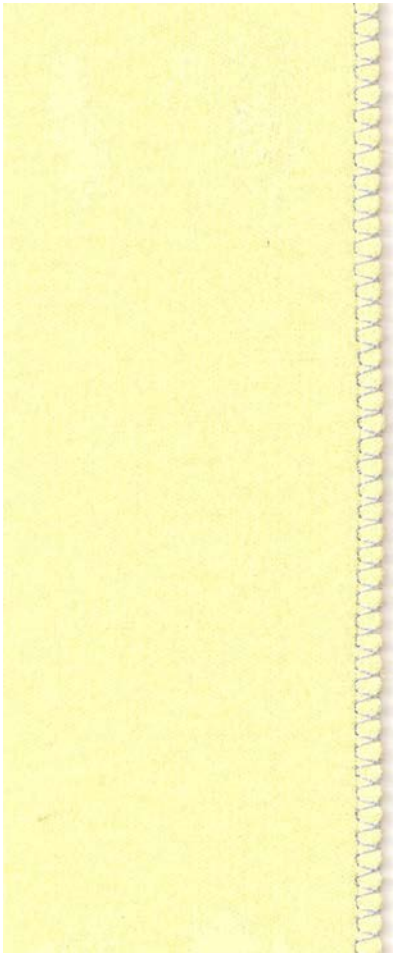





Sew HOW

Do you know how to:

- Engage the Needle Stop Down feature?
- Position Overlock Foot #2/2A?
- Select the foot in the Presser Foot Selection?

LONG STITCH

-  Wool-like fabric or Heavy flannel, 6" x 7"
-  80/12 Universal
-  Polyester or cotton sewing thread
-  Default
-  Reverse Pattern Foot #1/1C/1D, Sole #1



NOTE: This fabric sample will be used with the Blind Hem Exercise on the following page.

B 880 PLUS, 790 PLUS, 770 QE, 590 Only Engaging/Disengaging Long Stitch Function

NOTE: All other models, follow the instructions below, but use a straight stitch with stitch length of 6.



1. **Optional:** Finish one 6" edge of the fabric with a zigzag stitch, the Vari-Overlock Stitch, or an overlock machine.
2. Fold a 2" hem to the wrong side of the fabric and press.
3. Select the straight stitch. Touch clr to clear any previous changes to the stitch.
 - If using Long Stitch, select the "i" menu and touch the Long Stitch icon.
 - On models without Long Stitch, increase the stitch length to 6 mm.
4. Baste the hem in place, sewing about 3/4" from the finished edge of the hem (if done in Step 1).
5. Press clr to return to a standard straight stitch.
6. Close the "i" screen.
7. Use this sample for the Blind Hem exercise on the next page.

Tips:





- Adjust the straight stitch length to 5 mm or 6 mm on the B 880 PLUS and 790 PLUS, 590, and 570 QE models; engage the Long Stitch function for the longest straight stitch, about 1 1/4" long.
- Use the Long stitch function with a triple straight stitch for a beautiful saddle stitch for topstitching.

Sew HOW

Do you know how to:

- Engage the Long Stitch function?
- Use the Long Stitch function for basting and for topstitching?

BLIND HEM

-  Wool-like fabric or heavy flannel, 6" x 7"
-  80/12 Universal
-  Polyester or cotton sewing thread
-  As programmed
-  Reverse Pattern Foot #1/1C/1D, Sole #1 for basting
Blindstitch Foot #5, Sole #5 (optional accessory for B 770 QE, 740, 570 QE, 535)

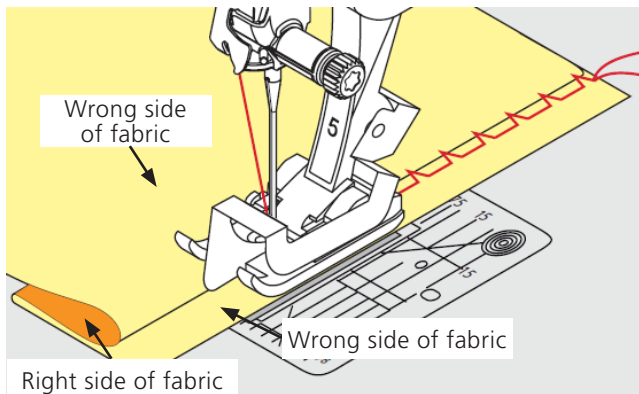
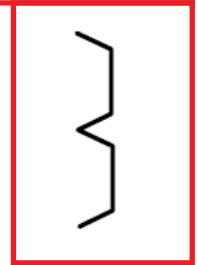

1. Begin with a basted 2" hem as instructed on previous page.
2. Select the Blind Stitch #9.
3. Attach the Blindstitch Foot #5 to the machine.
4. Fold the hem back to the right side over the basting line, exposing the zigzagged edge of the fabric.
5. Sew on the extended hem allowance, keeping the folded edge next to the guide on the foot.
6. Adjust the stitch width if needed so that the needle barely stitches into the fold.
7. Unfold the fabric when finished, and notice that the stitches barely show on the outside of the fabric.







Sew HOW

Do you know how to:

- Machine baste?
- Distinguish between Blindstitch Foot #5 and Edgestitch Foot #10/10C/10D?

STRETCH STITCH

-  Spandex, 4" x 6", two pieces
-  80/12 Universal (Ballpoint or Stretch may also be used)
-  Polyester or cotton sewing thread
-  As programmed
-  Reverse Pattern Foot #1/1C/1D, Sole #1



1. Attach Reverse Pattern Foot #1/1C/1D to the machine.
2. Select the Super Stretch Stitch #11.
3. Place the fabric pieces right sides together.
4. Position the edge of the fabric on the 5/8" marking on the stitch plate.
5. Sew the seam.

NOTE: If the fabric is pulling and stretching as it is sewn, adjust the presser foot pressure to a lower number to lighten the pressure of the foot on the fabric and eliminate the stretching.









Sew HOW

Do you know how to:

- Adjust the presser foot pressure?
- What fabric types you would use with this stitch?

BALANCE

-  Firm woven fabric, 4" x 6"*
-  Lightweight tear-away stabilizer 4" x 6"*
-  80/12 Universal
-  Polyester or cotton embroidery thread
-  Default
-  Open Embroidery Foot #20/20C/20D, Sole #20

*or use Classroom Sampler Fabric

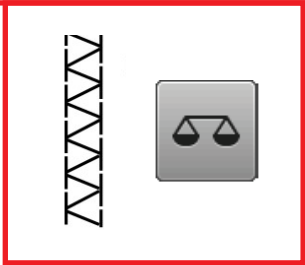

Notes:

The Balance function is generally reserved for fine tuning the stitch appearance, but is sometimes required because of differences in fabrics and threads.

The Balance Function is used to troubleshoot and fine tune stitches if they do not produce desired results with default settings. Oftentimes, this is caused by unusual fabrics or threads.

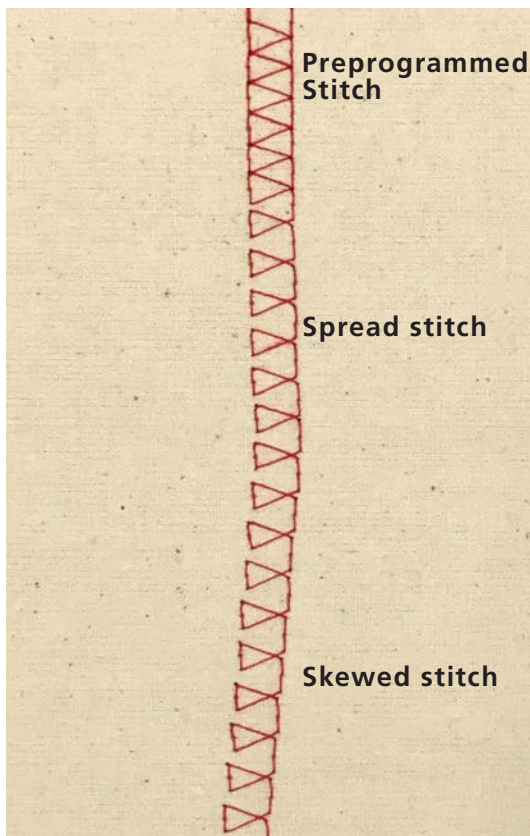

1. Attach Open Embroidery Foot #20/20C/20D.
2. Place the stabilizer behind the fabric.
3. Select the Double Overlock Stitch #10; sew about 1 1/2".
4. Select the 'i' icon and select Balance; the right side of screen shows stitch pattern as programmed.



5. Use the Lower Multifunction (Stitch Length) knob or the lower +/- icons to adjust the stitch to match the Spread Stitch (see sample to left); stitch for another 1 1/2".
6. **B 880 PLUS and B 790 PLUS only:** use the Upper Multifunction knob or the upper +/- icons to skew the stitch to the left/right; stitch for another 1 1/2".
7. CLR returns the stitch to normal settings.

Sew HOW

Do you know how to:

- Fine-tune the stitch balance on your model?

AUTOMATIC BUTTONHOLE PROGRAM

-  Wool-like fabric or heavy flannel, 6" x 6"
-  Lightweight tear-away stabilizer 3" x 6"
-  80/12 Universal
-  Polyester or cotton embroidery thread
-  As programmed
-  Automatic Buttonhole Foot #3A (optional accessory for B 475 QE and B 435)
-  3/4" (19 mm/30L) two-hole button
-  18" Narrow cord (perle cotton, embroidery floss, etc.)

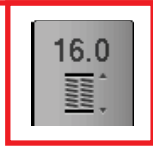

1. Fold the fabric square in half to 3" x 6". Press.
2. Insert the stabilizer between the layers.

On-screen Buttonhole Measuring

1. Attach Automatic Buttonhole Foot #3A.
2. Select the Buttonhole menu; select Standard Buttonhole #51.
3. Select the "i" menu and select the Buttonhole Length icon.
4. Hold button to the screen inside the yellow outline. Use the Multifunction Knobs to enlarge or decrease the circle size until it encircles the button.
 - The length is calculated directly from the button diameter. 2 mm are automatically added for button ease/thickness.
5. Sew the buttonhole. The buttonhole is repeatable without re-setting.



Tips:

- Because Automatic Buttonhole is a program, it needs to stitch to completion. Keep the Foot Control depressed until the machine stops stitching, or use the Start/Stop button to stitch the buttonhole.
- Buttonhole Bead Width and Stitch Density are also adjustable using the Multifunction Knobs in the sewing view.

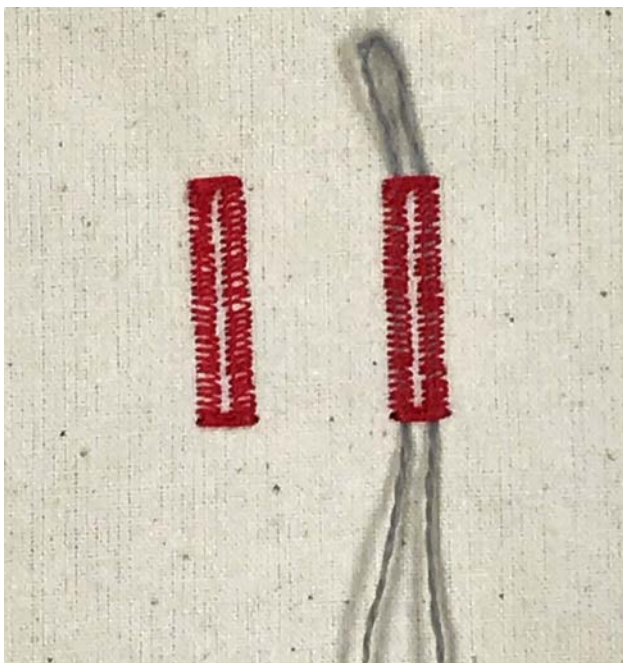

Corded Buttonhole

1. Fold the cord in half and loop the middle around the center "toe" of the foot.
2. Stitch a second buttonhole. Carefully remove the fabric from under the foot.
3. Pull the cord ends until the loop is pulled up under the buttonhole stitches; trim the ends of cord.
 - If working on a knit fabric, knot the cord ends together before trimming.
4. Store this buttonhole in Memory. See next page for details.

Sew HOW

Do you know how to:

- Program a buttonhole on-screen?
- Adjust buttonhole bead density?

MEMORY BUTTONHOLES

Long Term Buttonhole Memory allows you to save buttonholes that you use over and over (shirts, for example). Multiple Buttonholes may be stored in the Personal Program and retrieved as needed.

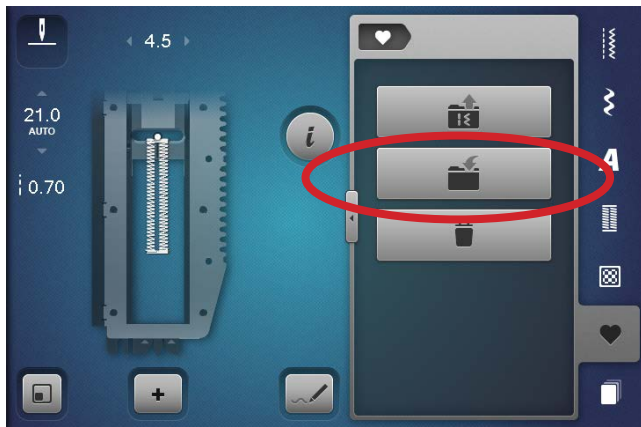
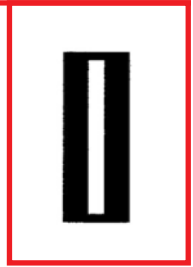

To Save a Buttonhole in Memory

1. After the buttonhole you wish to save is complete, select the Personal Program Menu.
2. Press the Save icon.
3. Select one of the 4 folders.
4. Touch the buttonhole to be saved (outlined in yellow), or select the green check box.

To Retrieve a Buttonhole from Memory







1. To retrieve the saved buttonhole (if testing this in class, turn machine off and wait 60 seconds before turning machine back on).
2. Select the Personal Memory icon.
3. Select the Retrieve icon.
4. Select the folder (1-4) where you saved the buttonhole.
5. Touch the desired buttonhole icon and it will appear on the Editing screen and be ready for stitching.

Sew HOW

Do you know how to:

- Program a buttonhole into the memory of your machine?
- Retrieve a programmed buttonhole?

MANUAL BUTTONHOLES

-  Wool-like fabric or heavy flannel, 6" x 6"
-  Lightweight tear-away stabilizer 3" x 6"
-  80/12 Universal
-  Polyester or cotton embroidery thread
-  As programmed
-  **Buttonhole Foot #3/3C, Sole #3**
(optional accessory B 790 PLUS, 770 QE, 740, 590, 570 QE, 535)

NOTE: Use the Manual Buttonhole when you wish to make a buttonhole longer than 29 mm (the maximum length of an Automatic Buttonhole).

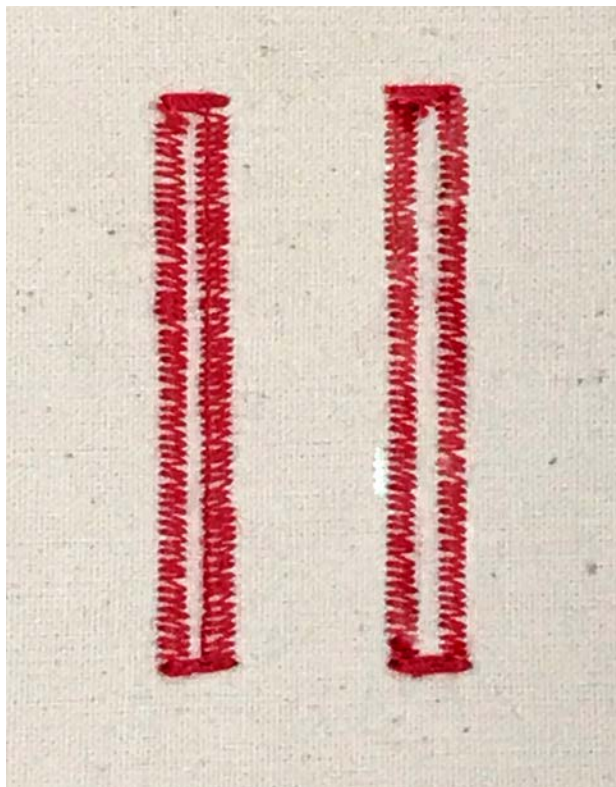

1. Fold fabric in half to 3" x 6" and press.
2. Insert stabilizer between the layers.
3. Mark two dots 1 1/2" apart to simulate the length of buttonhole needed.
4. Attach Foot #3/3C. Select Foot #3/3C in the Presser Foot Selection screen.

Stitch Standard Buttonhole

1. Select the Buttonhole menu; select Standard Buttonhole #51. (Touch clr to clear any previous changes.)
2. Touch the "i". Select the "man" function from the function toolbar.
3. Align the first dot directly under the needle.
4. Sew the first step of the buttonhole. Stop at the second dot marked on the fabric.
5. Press the Quick Reverse button to advance to the next step.
6. Continue in the same manner with the remaining steps.

Buttonhole Slit Width Adjustment

NOTE: Not available on the B 475 QE or B 435

1. Select the Buttonhole menu; select Standard Buttonhole #51.
2. Select the "i" to expand the Information Screen. Select the Buttonhole Slit Width. 
3. Use the Multifunction Knobs to adjust Buttonhole Slit Width to accommodate thick or unusual buttons.
4. Sew the buttonhole.

Sew HOW

Do you know how to:

- Measure a button for buttonhole size?
- Adjust buttonhole slit width on an Automatic Buttonhole?

ATTACHING BUTTONS

-  Firm woven fabric, 4" x 8"*
-  Lightweight tear-away stabilizer 4" x 4"*
-  80/12 Universal
-  Polyester or cotton embroidery thread
-  As Programmed
-  **Button Sew-On Foot #18**
(optional accessory B 790 PLUS, 770 QE, 740, 590, 570 QE, 535, 480, 475 QE, 435)
-  Feed dogs down
-  **3/4" (19 mm/30L) two-hole button**

*or use
Classroom
Sampler Fabric



Tips:

- Using the lowest shank setting and the instructions above attach a charm(s) or snap or hook and eye.
- Stitch a ribbon with this technique (the stitch makes a bartack) and then tie the ribbon into a bow.

1. Attach the Button Sew-On Foot #18 to the machine and lower the feed dogs.
2. Select the Button Sew-On Program #60.
3. Fold the fabric in half to 4" x 4" and press.
4. Insert the stabilizer between the layers of fabric.
5. Adjust the pin on the Button Sew-On Foot #18 to the desired position.
 - A short shank is appropriate for dress-and blouse-weight fabrics.
 - A long shank is appropriate for coat and jacket-weight materials.
6. Check the distance between the holes of the button by turning the hand wheel. Adjust the stitch width if necessary so that the left and right swings of the needle fall into the holes of the button. Hold the thread tails as you begin to sew.
7. When using the Button Sew-on Program, the machine stops automatically when the program is complete (keep the Foot Control fully depressed until the machine stops, or use the Start/Stop button); the thread tails are secured as part of the program.



Sew HOW

Do you know how to:

- Lower the feed dogs?
- Adjust the shank on Button Sew-On Foot #18?

CREATIVE CONSULTANT-ZIPPER INFORMATION

The Creative Consultant provides information and help with various sewing techniques, including zippers. After selecting the fabric and the desired sewing technique, suggestions for suitable needle, presser foot, etc. are displayed.



1. Touch the Creative Consultant icon.
2. Choose the fabric.
 - Select the Help Program icon.
 - Select the Medium-weight woven icon. A list of medium weight fabrics is displayed.
 - Close the help screen.
3. Select the Medium-weight icon again and the Sewing Techniques Screen will open.
4. Choose the desired Sewing Technique.
 - Choose Zipper. Recommendations for the selected material and the desired sewing technique are displayed.
 - Any icon with a + in the lower right corner can be selected and more information will be displayed.
 - To commence sewing with the program suggestions, select the green check box to confirm and the display with the programmed stitch patterns appears on the screen.
 - Otherwise, select the red x box to close the screen without making changes.

Sew HOW

Do you know:

- How to access Creative Consultant?
- When to use the Help Program?

COMBI MODE-STITCH PATTERNS

Combi Mode is used to combine alphabets and/or stitch patterns to create new custom stitch patterns. Stitches can be altered individually using the "i" settings, or the whole combination can be altered. Refer to the machine manual for limitations. Combi Mode can be used with 9 mm and/or Sideways Motion stitches with machines that have sideways motion capabilities. Stitch the combination using an appropriate foot for the stitches in the combination.



Programming Combi Mode

1. Select the Combi Mode (+) icon and the stitch altering area becomes the combination area. (On the B 880 PLUS, 790 PLUS, an action bar appears to the right of the stitch altering area to display the combination.) As a stitch is selected, it is added to the combination.
2. Select three decorative stitches. Decorative stitches can be added using the Search icon, or by selecting a stitch directly from any Decorative Stitch Menu. The following are suggested stitch combinations:
 B 880 PLUS, 790 PLUS, 770 QE, 740: 977, 942, 779 (scissors, needle & thread, machine)
 B 590: 2204, 2202, 2201 (scissors, needle & thread, machine.
 B 570 QE, 535, 480, 475 QE, 435: 906, 920, 712 (star, umbrella, heart)

Saving in Memory

1. Select the Personal Program icon.
2. Select Save.
3. Select the highlighted stitch combination to save.

Deleting Individual Characters

1. Delete by swiping:
 - Select a stitch from the Action Bar (B 880 PLUS/790PLUS), or from the Stitch Altering Area for other machines. (If a machine has an Action Bar, it must be used when deleting by swiping.)
 - Tap, hold, and move stitch out of the area (or to the right). Delete happens without confirmation.
2. Delete using the trashcan:
 - If the Information icon is open, the selected stitch can be deleted by swiping or by selecting the trashcan in the Information menu.

Deleting Combinations on Screen









1. Select the "i" button; select the Editing Complete Combination icon.
2. Touch the Delete (trashcan) icon.
3. Touch the green check box to confirm.

Retrieving Stored Memory

1. Open Combi Mode.
2. Select Personal Program; select the Combination Folder.
3. Select the desired combination.

COMBI MODE-LETTERING

-  Firm woven fabric, 4" x 6"*
-  Lightweight tear-away stabilizer 4" x 6"*
-  80/12 Universal
-  Polyester or cotton embroidery thread
-  Default
-  Open Embroidery foot #20/20C/20D, Sole #20

*or use Classroom Sampler Fabric



1. Attach Open Embroidery Foot #20/20C/20D.
2. Place the stabilizer behind the fabric.
3. Open Combi Mode. (If a previous combination is on the screen, delete the combination. See previous page for directions.
4. Select the Alphabet menu and select an alphabet.
5. Program BERNANA (misspelled).
6. To edit:
 - The cursor is the dotted line. Use the navigation arrows to scroll, OR
 - Select the first (incorrect) "A" in the list. Tap and swipe to delete the letter.
 - To insert the "I", select the letter before the insertion point (top "N") and type the "I". The insertion happens after the cursor.



Stitching a word combination:

1. Close the Transition window.
2. Open the "i" menu; select Editing the Complete Combination. Then touch Pattern Repeat 1x and stitch the design.
3. Save the combination using the instructions on Page 32 for accessing and programming the memory.

Using the Transition window to enter and edit text

1. Open Combi Mode. (If a previous combination is on the screen, delete the combination. See previous page for directions.
2. Touch the Transition icon to open the Transition Window and type in BERNANA (misspelled).
3. To edit in the Transition view:
 - Select the first (incorrect) "A" and select the Delete icon to the right.
 - To insert the "I", select the letter before the insertion point ("N") and type the "I".
 - Select Transition icon to close the screen.

Do you know how to: Sew HOW

- Insert at the beginning of a combination?
- Edit lettering already programmed?
- Retrieve a saved combination?

FREE-MOTION STITCHING

 **Two 12" x 12" pieces medium weight cotton**
One 12" x 12" piece low-loft cotton batting

 **80/12 Quilting needle**

 **40 weight quilting thread in needle**
60 wt thread in bobbin

 **Default**

Darning Foot #9 or
Freehand Embroidery Foot #24 or
Freehand Quilting Foot #29/29C
(optional accessories)
Teardrop Embroidery Foot #26 (optional
on some machines)

 **Feed dogs down**

Free Motion Tips:

- BERNINA presser feet designed for free-motion stitching have a patented hooper mechanism that holds the fabric as the needle pulls away, making it easy to move the fabric.
- The key to successful free-motion stitching is to run the motor at a consistent speed and move the fabric at a consistent and smooth speed.
- Set the Slide Speed Control to medium and floor the foot control, or use the Start/Stop button on the machine.



Free-motion stitching refers to sewing without the feeding aid of the sewing machine. The feed dogs are lowered and the fabric stays in the same place unless you manually move it. Free-motion stitching is used in quilting, bobbinplay, and thread painting.

1. Make a "quilt sandwich" with the batting between two layers of fabric and practice "drawing" a variety of shapes (see below) on fabric as follows:
2. Using the foot control or the Stop/Start button to run the machine, move the fabric in a forward and back motion.
3. Move fabric from top to bottom; then side to side, keeping the lines of stitching perpendicular to each other. (1)
4. Move fabric to the right, down, up, to the right, down and up. (2)
5. Move the fabric in smooth curves in an up and down motion working from left to right. (3)
6. Move the fabric in loops (4) or figure 8 shapes.
7. Create stippling shapes – think of interconnecting puzzle pieces with evenly sized "bumps." Avoid "painting yourself into a corner" and/or stitching across a previously stitched line. (5)

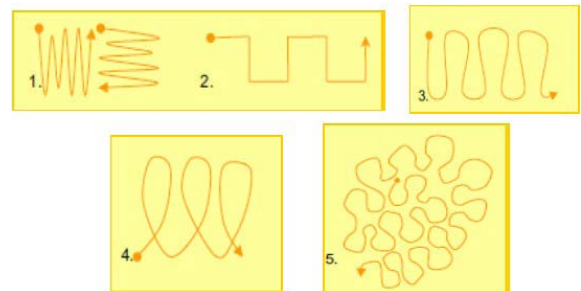

Sew **HOW**

Do you know how to:

- Lower the feed dogs?
- Move the fabric for even and consistent stitching?

BERNINA STITCH REGULATOR #42

B 880 PLUS, 790 PLUS, 770 QE, 590, 570 QE - Standard Accessory

B 740, 535, 480, 475 QE - Optional Accessory

Not compatible with the B 435

The BERNINA Stitch Regulator (BSR) is designed to assist with free-motion stitching techniques by helping to keep the stitch length regular and consistent, eliminating hours of practice.

The BSR Foot is equipped with three unique soles, each designed for different sewing situations.

- A closed, O-shaped, metal sole for detailed free-motion stitching techniques such as stippling, bobbin play, and thread painting.
- An open, C-shaped, metal sole for added visibility in front of needle when following printed or marked lines. The “prongs” of this sole are slightly curved, facilitating movement over several layers of fabric and/or thread.
- A large, clear plastic sole for echo-quilting and medium to large-scale free-motion stitching techniques. The large sole moves easily over raised areas; useful for stitching thick batting, as it compresses a larger area around the needle, increasing visibility. Cross-hairs and concentric circle markings aid in accurate stitch placement.



BERNINA Stitch Regulator Mode 1

When BSR Mode 1 is selected the needle immediately starts to move up and down, ready for the fabric to be moved for stitching.

BERNINA Stitch Regulator Mode 2

When working in BSR Mode 2, the motor is engaged only when the fabric is moved under the foot, giving the stitcher time to stop and think about the path the needle is taking.

NOTE: *If there is no movement for over approximately seven seconds, the BSR will automatically deactivate.*

Attach and plug in the BERNINA Stitch Regulator; lower the feed dogs. The 880 PLUS automatically lowers the feed dogs when the BERNINA Stitch Regulator is selected.

Set motor speed to maximum on the Slide Speed Control.

NOTE: *It is possible to stitch faster than the BSR can regulate. Engage the audio signal to alert you when you exceed the “speed limit”.*

Create a sample using the BERNINA Stitch Regulator using the sole and Mode of your choice, following the Free-motion stitching instructions on the previous page. When stitching is complete, raise the feed dogs to sewing position.

ON-SCREEN TUTORIALS

To access information about the BERNINA Stitch Regulator at any time, select the Tutorial icon; then BSR to obtain on-screen info.



Sew HOW

Do you know how to:

- Change the soles to the BERNINA Stitch Regulator?
- Access the BSR Tutorial?

BERNINA STITCH REGULATOR PRACTICE

 Two 12" x 12" pieces medium weight cotton
One 12" x 12" piece low-loft cotton batting

 80/12 Universal

 40 wt. quilting thread in needle
60 wt. thread in bobbin

 Default

 Bernina Stitch Regulator #42
(optional accessory for B 740, 535, 480, 475 QE)
Not compatible with the B 435

Use the BSR zigzag option to easily and quickly create freehand embroidery designs, shade or accent fabric motifs, and couch decorative fibers. For more information, refer to previous page and your machine manual.

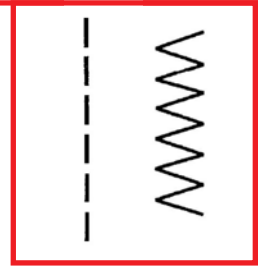

1. Make a "quilt sandwich" with the batting between two layers of fabric.
2. Attach the BERNINA Stitch Regulator to the machine and select the BSR Zigzag stitch.
3. Select Mode 1 or 2 as desired. Adjust presser foot pressure if needed. Lower the feed dogs. **NOTE:** The B 880 PLUS does this automatically.
4. Using a fabric marker, trace or draw leaf shape (1) on fabric, starting at the upper edge and drawing in one continuous line.
5. Place the fabric under the BERNINA Stitch Regulator foot.
6. Select the BSR straight stitch. Stitch the leaf shape, tracing lines several times (2).
7. Select the BSR zigzag stitch. Shade the left side of the leaf (3).
8. Experiment with different stitch lengths and widths, making note of your preferences.
9. When stitching is complete, raise the feed dogs to the sewing position. (The B 880 PLUS will automatically raise the feed dogs when the BSR is removed.)



Sew HOW

Do you know:

- How to attach the BERNINA Stitch Regulator to the machine?
- The difference between Mode 1 and 2?

SIDEWAYS MOTION PATTERNS



B 880 PLUS, 790 PLUS Only

The B 880 PLUS and B 790 PLUS have built-in Sideways Motion Patterns. These are found in Menus 201, 501, 801, 1001, 1201 and 1601 and are indicated by a directional symbol on the menu. A large monogram directional alphabet can be found in the Alphabet menu.

***or use
Classroom
Sampler Fabric**



Sideways Motion Scenarios

- Sideways Motion Stitches used in Combinations.
- Sideways Motion Stitches created in Stitch Designer.
- Using Drag & Drop to join stitch patterns in combi-mode frequently produces a Sideways Motion situation.
- Sewing with Distortion engaged (B 880 PLUS). 
- Engaging the Multi-Directional Sewing Icon. 



Sideways Motion Information

- Sideways Motion Stitches vary in size. When selected, the display on screen is in relation to the presser foot, so the entire view of the stitch may not be visible. If this is the case and you wish to see the entire view of the stitch, select the Fit to Window icon. 
- The white dot indicates the start point of the pattern, the red mark indicates the endpoint of the pattern.

Tips for Stitching Sideways Motion Stitches

- Always use Foot #40C for sideways motion sewing – no other foot is designed to stitch sideways successfully.
- Sideways motion stitches cannot be sewn with Dual Feed.
- Determine stabilizer needs based on fabric choice and stitch selections. Light-weight tear away stabilizer or starch may be needed.
- In Sideways Motion Stitching, the feed dogs move the fabric in multiple directions, including sideways, forward and backward to stitch the pattern.
- Only fingertip guiding (a very light touch) is recommended to allow the machine to make the angled movements at the pace required.
- Drawing parallel lines 1/2" apart on the fabric provides visual guidelines to keep the fabric straight and parallel to the foot.
- Sewing at a consistent medium speed is preferred in order to give the machine time to move the fabric for stitch formation. Setting the slide speed control will control an even speed.
- Engaging Pattern End (programmed as Pattern End only) provides a stopping point to check the sewing.



Do you know:

- **How to identify Sideways Motions Folders?**
- **Which foot to use for Sideways Motion Stitches?**

Sew **HOW**

MULTI-DIRECTIONAL STITCHING

B 880 PLUS, 790 PLUS Only

The B 880 PLUS and B 790 PLUS can sew Multi-directional stitches and stitch combinations in 360°. This allows angled sewing without angling the fabric. Use Sideways Motion Foot #40C for all multi-directional sewing.



- Select the stitch, then Information ("i"), then the multi-directional icon.
- Rotate the selected stitch in 45° increments by touching one of the direct-selection nodes on the screen (indicated by the yellow outlines in the graphics below).
- Rotate in 0.5° increments by turning the stitch width knob.
- Rotate in 1° increments by turning the stitch length knob.
- The Stitch Altering Area indicates the sewing direction of the stitch and the Start (•) and Stop (+) points of the selected stitch.
- The Multi-directional function only appears in the "i" menu when the selected stitch can be sewn in multiple directions.

Keys to Successful Multi-Directional Stitching

- Support fabric with stabilizer.
- Attach Slide-on Table.
- Draw parallel guidelines to aid in visually keeping the fabric straight.
- Use fingertip guiding (lightly holding the fabric without inhibiting or helping it).
- Attach Sideways Motion Foot #40C.



Stitch width knob--0.5° increments

Stitch length knob--1° increments

Sew **HOW**







Do you know:

- How to guide the fabric for Sideways Motion?
- Three ways to set the angle?

MULTI-DIRECTIONAL STITCHES

B 880 PLUS, 790 PLUS Only



-  Firm woven fabric, 10" x 10"
-  Heavyweight tear-away stabilizer 10" x 10"
-  80/12 Universal
-  Polyester or cotton embroidery thread
-  Default
-  Sideways Motion Foot 40C

DIRECTIONAL SEWING-Single Mode, Single Direction

1. Select Stitch #644. Select the "i" menu.
2. Select the Multi-Directional Sewing icon; set the angle to 135°.
3. When sewing this stitch, let the feed dogs move the fabric sideways to stitch the programmed pattern.
4. Select Pattern End to finish.

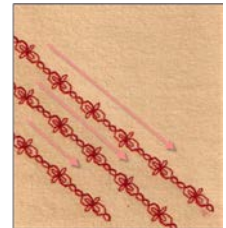

Directional Sewing-Programmed Combi (see sample on Page 43)

1. Open Combi Mode; use 0-9 and input 656 and Check.
2. Select 0-9 to close. Add a second copy of 656.
3. Select "i"; select pattern 1.
4. Select the Multi-directional icon and set the angle to 135°.
5. Select pattern 2. Select the Multi-directional icon; set angle to 225°.
6. Select the "i" breadcrumb.
7. Select All (Edit the Complete Combination icon).
8. Set Pattern Repeat to 2 and stitch. (Selecting Modify Screen provides a preview of the stitch).
9. Select Modify Screen to exit.

Applying Multi-Direction to a Combination

1. Open Combi Mode. Select one of the saved combinations from Personal Program or create a new combination. If needed, delete the current combination following Page 33 instructions.
 - Use 0-9 to add stitches #751 and #749, selecting check after each entry.
 - Select 0-9 to close.
2. Select "i"; select All (Edit the Complete Combination icon).
3. Select the Multi-directional icon and turn the knobs to set the sewing angle.
4. If no presser foot is selected (yellow setting), Sideways Motion Foot #40 becomes the recommended foot.

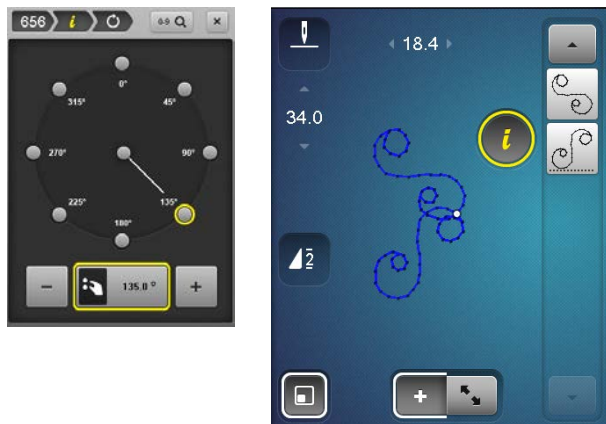

CONNECTING STITCHES

B 880 PLUS, 790 PLUS Only

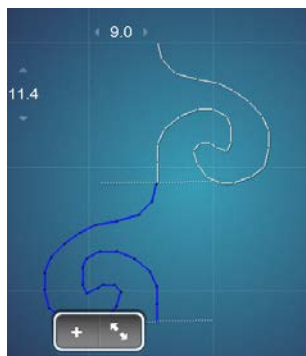
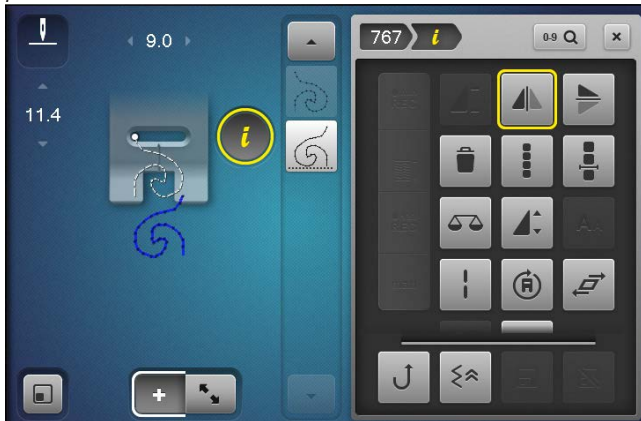

Using Drag & Drop with Combinations

1. Open Combi-Mode and delete by swiping any stitches that are present.
2. Select Decorative Stitches; select Menu 701. Select Stitch 767 two times.
3. Select 'i' and engage Mirror Image Left/Right on the second pattern. The needle stop and start points are not the same for the 2 stitches, and a jump stitch will be sewn joining them.
4. Select Overview Combi Mode to create a continuous stitch. Move (Drag & Drop) the second pattern (blue) to line up with the first one as shown. Use the stylus and 'drag & drop' on screen or use the Stitch Width multi-function knob.
5. The new combi shows as a continuous stitch in the preview.
6. Select Overview Combi Mode to return to the stitch out screen. The combination will display the sideways motion icon between the stitches. This indicates the machine calculation of the move motion required to stitch what was drawn on the previous screen.
7. To stitch, attach Foot #40C (as recommended by the presser foot recommendation icon if there is not a foot set previously). Use the fabric swatch from previous page.
8. Close "i".
9. To Save the combination, select Personal Program. Select Save and select the highlighted combination.
10. To delete the entire combination from the screen view with a single command, select 'i', and select all (Editing the Complete Combination) and Delete (trashcan). Confirm and close the menu.
11. Try the same exercise with Sideways Motion Stitch #237.

Sew HOW

Do you know how to:

- Eliminate jump stitches between patterns?
- See a preview of the combination?

CONNECTING STITCHES AND MOVE MULTIPLES

B 880 PLUS, 790 PLUS Only

When stitches are moved to connect up, it can cause the overall pattern to have a gap, particularly if the stitches are moved to overlap. To achieve a continuously stitched pattern, use Move Multiples.

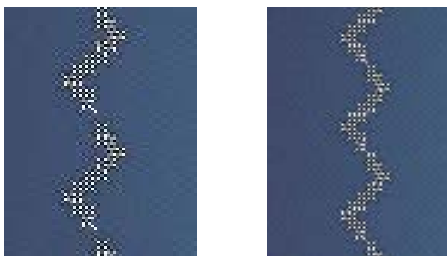
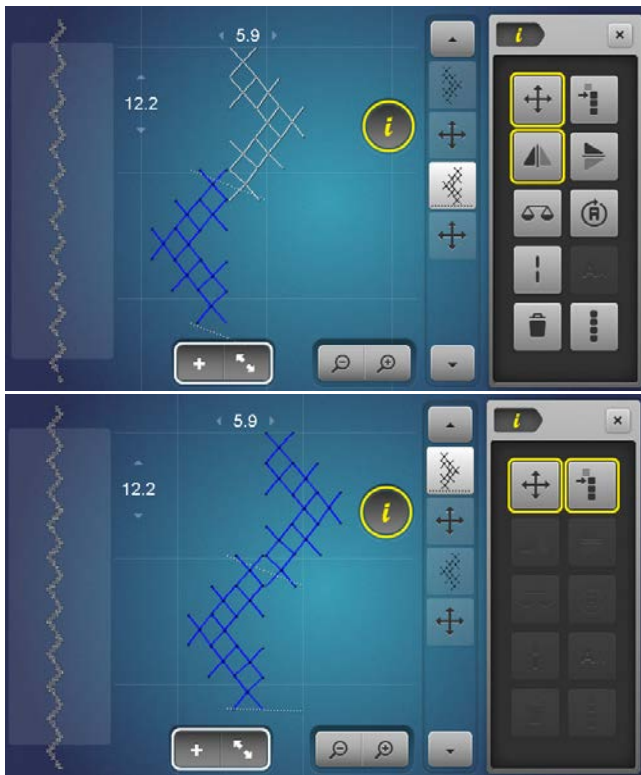

Using Move Multiples to Close the Gap in a Combination





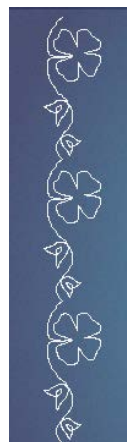

1. Open Combi-Mode and delete by swiping any stitches that are present.
2. Input stitch #376 two times.
3. Select the Overview Combi Mode.
4. Select 'i'.
5. Engage Mirror Image Left/Right on the second stitch.
6. Drag and Drop (with the stylus or finger) to move the stitches to connect as shown. To fine tune the placement, use the multi-function knobs if necessary.
7. Looking at the preview on the side of the screen, the patterns do not connect.
8. Select the first motif in the combi.
9. Select the Move Multiples Icon.
10. Use the Stitch Length knob to close the gap watching the preview area.
11. Select Overview Combi Mode to return to the main sew out screen.
12. Pattern may be stitched and/or saved through Personal Program.
13. Try the same exercise with Sideways Motion Stitch #237.

Floral Combi

1. Open Combi-Mode and delete by swiping any stitches that are present.
2. Select 0-9 and input stitch #244 and #238.
3. Select Modify Screen.
4. Select 'i' and mirror image Left/Right second pattern. If Mirror Image is not available, deselect Move Multiples.
5. Drag and Drop to connect the stitches. To fine tune the placement, use the multi-function knobs if necessary.



ALL-OVER DIRECTIONAL STITCHING

-  Firm woven fabric, 6" x 6"
-  Heavyweight tear-away stabilizer 6" x 6"
-  80/12 Universal
-  Polyester or cotton embroidery thread
-  Default
-  Sideways Motion Foot 40C

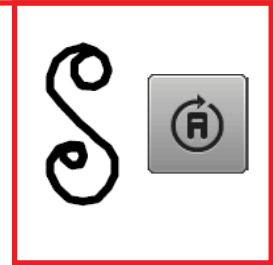

FOR B 880 PLUS AND B 790 PLUS ONLY

This exercise features an all-over design created by selecting one stitch (#656 is shown in the sample) and changing directions as you sew.

Notes:

- Some adjustments may be necessary depending on the fabric, thread, and stabilizer used to create the stitch sample.
- This technique can also be created by importing sewing machine stitches into Embroidery, which will be covered in BERNINA Embroidery Machine Workbook.

1. Place stabilizer behind fabric.
2. Mark parallel guide lines about 1" apart on the fabric as a reference for guiding during the stitching process.
3. Select "i"; select Multi-Directional Sewing. Select 225° on the compass.
5. Select the "i" in the breadcrumb; Pattern Repeat 1x. Ensure that Needle Stop Down is set.
6. Stitch one stitch pattern and stop; do not remove the fabric.
7. Select Multi-directional Stitching; select 135° on the compass, leaving Pattern Repeat 1x and Needle Stop Down engaged.
8. Stitch one stitch pattern and stop; do not remove the fabric.
9. Stitch from one end of the fabric to the other, guiding fabric so that the "+" stays parallel and perpendicular to the presser foot.
10. Stitch additional rows of this stitch combination, covering the surface of the fabric.

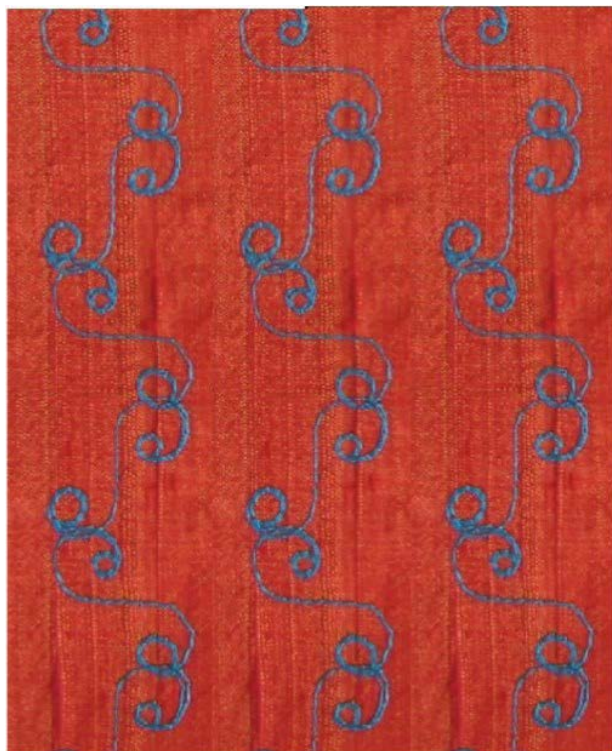

Optional:

Create a 4-sided motif by selecting 315° and 45° as the third and fourth sides.

Sew HOW

Do you know how to:

- Change directions in 45° increments when Multi-Directional stitching?

STITCH DESIGNER OVERVIEW

B 880 PLUS, 790 PLUS Only

Stitch Designer has the ability to create entirely new stitches or to modify new ones. Stitches can be created by tapping points or free-hand draw with the stylus or fingertip. Variable sizes of stitches are possible.



Stitch Designer Tips

- 20 levels of UNDO.
- Created patterns are limited to 2,000 stitches each.
- Each grid equals 1 mm.
- The line in the middle of the stitch designer drawing area represents the center needle position.
- Use Snap to Grid for precise placement.
- Created stitches are sewn only from the sew out screen after confirming with the check in Stitch Designer.
- Created stitches can be 1) saved to the machine memory through Personal Program, 2) imported into embroidery and embroidered, or 3) saved to a USB stick for swapping or imported into the BERNINA Embroidery Software.
- Stitches from the BERNINA Embroidery Software can be imported into the B 880 PLUS/790 PLUS via a USB Stick and Personal Program. This includes stitches not found on the machine such as candlewicking or blackwork stitches, as well as any stitches designed in the software.

STITCH DESIGNER

B 880 PLUS AND B 790 PLUS ONLY

Creating New Stitches-Free-hand Drawing

1. Select the Stitch Designer icon from the sewing screen.
2. Touch the New icon to get a fresh page. The Pencil is the default when entering Stitch Designer.
3. With your fingertip or stylus, free-hand draw on the screen to fill the 9 mm boundary. Begin and end on the same or approximate vertical grid line for a seamless look.
4. Select New or Undo until pleased with the stitch.

NOTE: The highlighted area is 9 mm wide. The 9 mm lock icon is activated by default. If you wish to design a stitch wider than 9 mm, deselect the 9 mm lock.



Creating New Stitches-Snap to Grid

1. Touch the New icon to start another stitch.
2. Select snap to grid icon. Snap to Grid makes it easy to align points as stitch points will only fall on a dot (note the grid changed to dots).
3. Select the Pencil tool.
4. Design stitch by setting points:
 - Click 1: to begin stitch
 - Click 2: 3 grids down
 - Click 3: diagonal line 1 grid up and 1 grid over
 - Click 4: diagonal line 1 grid down and 1 grid over
 - Click 5: diagonal line 3 grids up and 2 grids over
 - Click 6: diagonal line 3 grids down and 2 grids over
 - Click 7: diagonal line 1 grid up and 1 grid over
 - Click 8: diagonal line 1 grid down and 1 grid over
 - Stop
5. Touch the Select All icon. Selected stitches are blue, and the Selection Icon changes to the selected choice.



6. Select Duplicate; the duplicate is added after the original pattern.

Notes:

The Delete icon (Trash Can) deletes whatever is selected--a single point, all or partial-whatever is blue is selected.

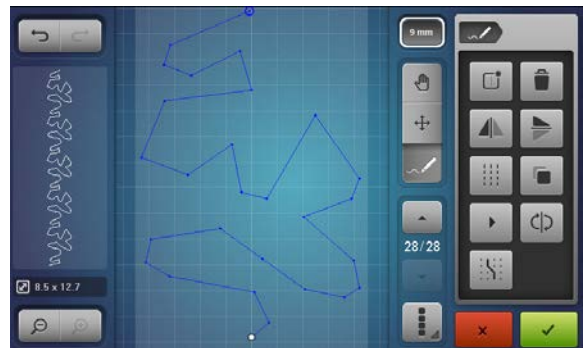

STITCH DESIGNER

Creating New Stitches--Snap to Grid (cont.)

7. Select Mirror Image Up/Down.



The preview window shows what the design will look like when it is stitched.

8. Deselect Snap to Grid. With the duplicated part of the design still selected, select the Move Icon.



- Use the Stitch Length knob to move the design to overlap the first part of the design.
- The Stitch Width knob may also be used to move the design left and right if desired.

9. Play Stitch Preview (acts like Slow Redraw).



10. Touch the green check box to confirm the stitch pattern and return to the sewing screen.

11. Stitch out the new stitch if desired.

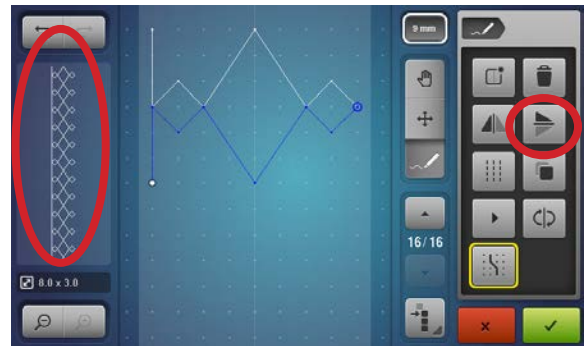

Save the New Stitch to Personal Program

1. From the Sewing Screen, select the Personal Program icon to save the custom stitch pattern.
2. Select the Save icon, and choose one of the 4 yellow folders.
3. Save the stitch by touching the new stitch (outlined in yellow), or by touching the green check box.

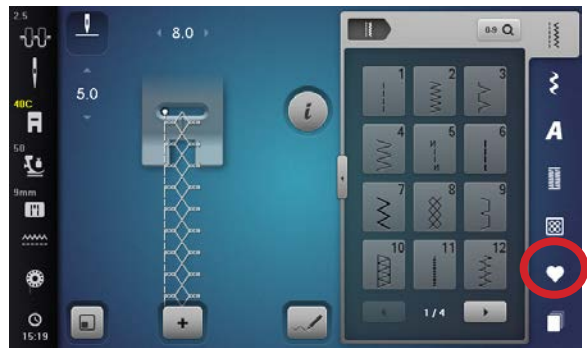

Sew HOW

Do you know how to:

- Freehand draw a new stitch?
- Create a stitch by tapping points?

STITCH DESIGNER

Editing an Existing Stitch (B 880 PLUS/790 PLUS Only)

1. From the Sewing screen, select menu 700 and stitch 736.
2. Select the Stitch Designer icon.
3. To move through a design, locate the current stitch point (indicated by the largest dot, and exact stitch number is noted in Active Stitch/# of stitches).
4. The up and down arrows allow you to move through the stitch pattern point by point.* Touch the up arrow to move to position 8 / 27.
5. Select the Move icon.
6. Drag the point in toward the center, or use the stitch length knob to move the point.
7. Repeat this operation on the two remaining sides.
8. Select the green check box to confirm; sew out or save to Personal Program.

*Alternate method of selecting points: Select Move; touch the stitch point you wish to move.

Adding a Stitch Point

1. Select Move and touch the stitch point just before the position you would like to add a new stitch point. (Or use the Up/Down arrows to scroll to the stitch point just before the position you would like to add the new stitch point.)
2. Select the Draw (pencil) icon and tap on line where you would like the new stitch point to be added.
 - A new large dot appears indicating the location of the new stitch point.
 - If the stitch does not go where you want it to, touch the Undo icon to remove it.
3. Select the Draw (pencil) icon and touch a point after the selected stitch point where you would like the new stitch point to be added.
4. Select the Move icon and move the new stitch point as desired.

Change a Single Stitch to a Triple Stitch

1. From the sewing screen, select any single stitch design (try #613).
2. Touch the Selection icon; touch Select All.
3. Select the Triple Stitch icon.
4. Select the green check box to return to the Sewing Screen; sew out or save to Personal Program.

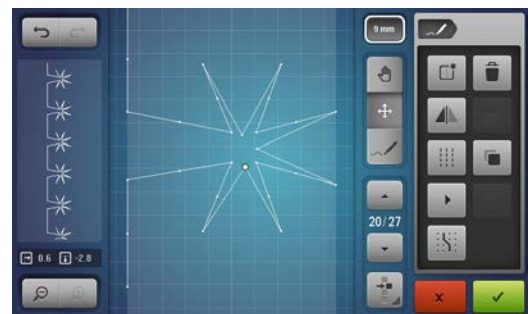
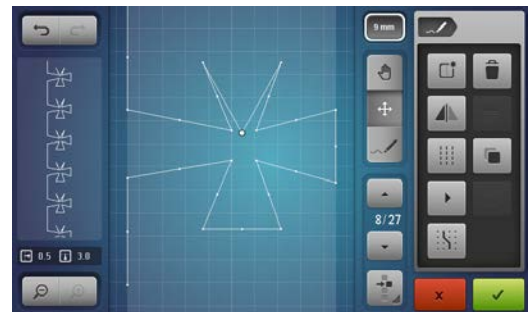
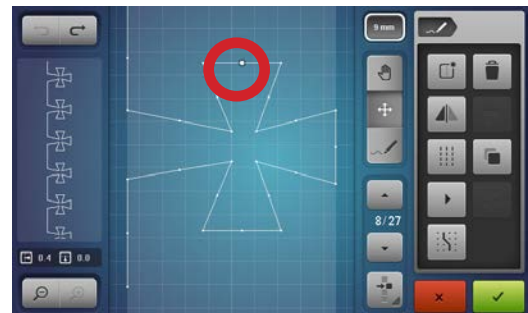
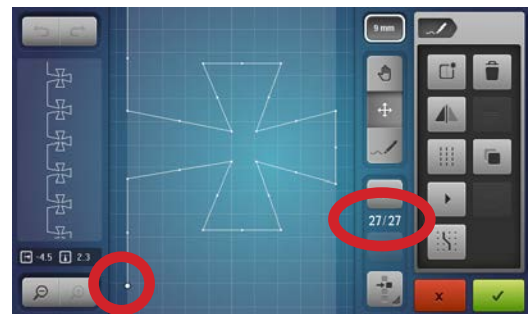

Sew HOW

Do you know how to:

- Move through the design two ways?
- Use Undo?

SAVING A STITCH DESIGNER STITCH TO A USB STICK

B 880 PLUS, 790 PLUS Only

Once a stitch created in Stitch Designer has been confirmed and appears on the sew out screen, it can be saved to the machine's memory or to a USB Stick that has been inserted in the machine.



1. While the created stitch is on the screen, select the Personal Program icon.
2. Select Save.
3. Open the Transition screen. Only at the Full View (transition) is the USB option visible.
4. Select the USB Stick.
5. Select the highlighted stitch and the stitch is saved to the USB Stick.

NOTE: To retrieve a stitch from a USB Stick, use the transition to access the USB; select Retrieve.

IMPORTED STITCHES FROM BERNINA SOFTWARE







1. In the BERNINA Embroidery Software, get one repeat of a stitch on the screen such as one candlewicking knot.
 - Select the Machine Write icon; select the USB option.
2. Put the USB stick in the B 880 PLUS/790 PLUS.
3. Select Personal Program; select File Retrieve (arrow out of folder).
4. Select the transition icon; then the USB icon. Select the stitch.
 - The imported stitch is only the candlewicking dot and has no travel stitches, so the stitch will stitch on top of itself.
5. Open the Stitch Designer. The active dot indicates the last needlepoint in the stitch.
6. Select Snap to Grid.
7. Select the Draw icon (pencil) and draw 5 stitches to create travel stitches. As the stitch changes, the Preview shows the overall impact to the stitch. When the desired spacing is achieved, touch the green check box to confirm.
8. Save the stitch to the machine's Personal Program and stitch a test using the Open Embroidery Foot #20.



NOTE: Use BERNINA Embroidery Software to design stitches as well. Writing a script name using the open freehand tool may be easier on the computer than on the machine.

- Resize the stitch as desired using the tool options; rotate 90°.
- Select Write to Machine and select USB.
- Once the stitch is on the USB stick, it can be opened via Personal Program.

DISTORTION

-  Firm woven fabric, 10" x 10"
-  Heavyweight tear-away stabilizer
10" x 10"
-  80/12 Universal
-  Polyester or cotton embroidery thread
-  Default
-  **Sideways Motion Foot 40C MUST be used**



B 880 PLUS Only

Distortion (Distorting Stitch Patterns) is a fun way to play with decorative stitches. The Sideways Motion Foot 40C MUST be used because of the sideways movement of the feed dogs. Distortion may NEVER be sewn with Dual Feed engaged. Dual Feed can not be used with Sideways Motion stitching.

1. Attach Sideways Motion Foot 40C; place heavyweight tear-away stabilizer behind fabric.
2. Select Menu 401 and select from the assortment of compact satin stitches.
 - Try stitches such as 401, 402, 405, 406, 414, 415, 427, 429.
 - Compact Satin 9 mm stitches may offer the most dramatic results, but try others, such as #711 (pictured on far left).
3. Attach Sideways Motion Foot #40C.
4. Select Distortion from the "i" menu.
5. Begin sewing on 10" square piece of fabric backed with lightweight stabilizer.
6. Turn the Stitch Width knob to the right and left while sewing. This creates wavy baselines for extraordinary creative effects.

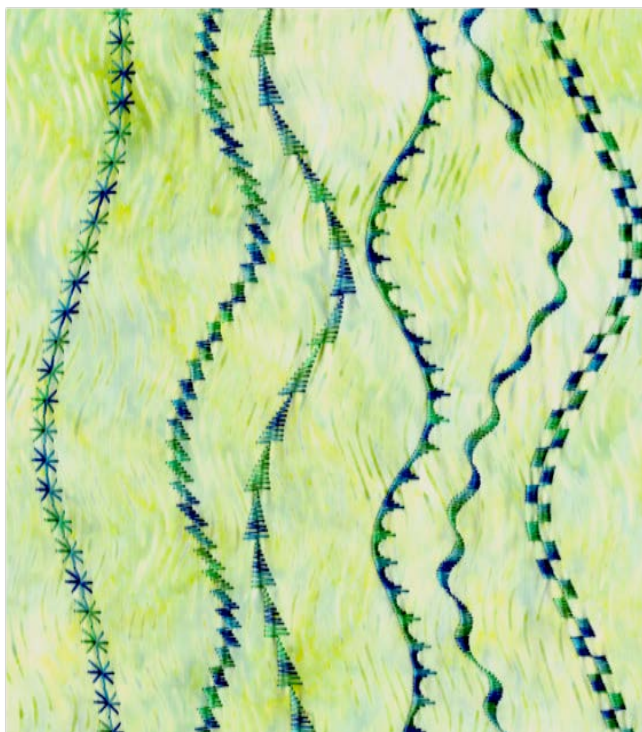

Sew HOW

Do you know how to:

- Adjust the Distortion function as you sew?

REFERENCE - BERNINA PRESSER FEET



BERNINA PRESSER FEET

- are engineered for specific functions
- are Swiss-engineered for the highest quality
- are one-piece metal feet, making them sturdy and durable
- are easy to change with one hand, requiring no special tools
- have a white shank, making it easier to see the eye of the needle, resulting in easier threading
- are, in some cases, modeled after commercial feet used in factories to increase speed and production with professional results
- do the job intended in relation to all types of sewing (example: quilting, garment-making, home dec, etc.)
- are supported by the best and most complete educational materials in the industry, including reference books detailing each feet and its uses.

Understanding the Numbers/Letters

BERNINA presser feet are numbered and may have one or two additional versions with a letter that follows the number, such as Edgestitch Foot #10C or Jeans Foot #8D.



Number Only

- The number without a letter refers to a foot engineered for BERNINA models that have a maximum stitch width of 5.5 mm.
- These feet may also be compatible with models that have a 9mm width when a 9mm width is not desired, such as when making pintucks with feet #30, 31, 32, or 33.



The Letter "C"

- When a foot number is followed by a "C", it indicates a version of the foot made for models with a maximum stitch width of 9mm.
- The "C" stands for "coded", and refers to the sensor on the foot that works with the electronics of the machine to engage the wider stitch width.
- The sole of the "C" foot is usually larger to fit the wider feed dogs.
- Exceptions: Overlock Foot #2/2A: 2A is larger to fit the wider feed dogs, but does not have a sensor for a wider stitch because the overlock stitches are not used at wide widths. Extra Wide Gathering Foot #16C: 16C is larger to fit the wider feed dog but does not have a sensor for a wider stitch width.



The Letter "D"

- The feet that have a number followed by a "D" are designed to work with the 8 Series and 7 Series, B 590 and 570 QE Dual Feed feature.
- After attaching the foot, the Dual Feed mechanism is positioned in the cutout on the back of the foot, engaging the BERNINA Dual Feed system.
- When using D Feet, the BERNINA Dual Feed System **MUST** be engaged. Using Dual Feed Feet without engaging the Dual Feed yields an incomplete sole and sacrifices control over the fabric.



Easy-On/Easy-Off Soles

- The BERNINA 475 QE and 435 have simple-to-use, easy-on/easy-off metal soles that attach to a standard shank. These BERNINA models are also compatible with the one-piece full-shank presser feet available as optional accessories for all BERNINA machines.

REFERENCE - SEWING MACHINE NEEDLES

Needle "Secret" Code

- DRI = Triple
- E = Embroidery
- J = Jeans
- L, LL, R = Leather
- M = Microtex
- MET = Metallic
- N = Topstitching/
Cordonnet
- Q = Quilting
- S = Stretch
- SUK = Fine Ball Point
- SES = Medium Ball Point
- WING = Wing
- ZWI = Double
- ZWI = Double
- ZWIHO = Double Wing

Needle Size Conversion

Regardless of the system, the greater the number, the larger the diameter of the needle.

European vs. Domestic

60=8	90=14
70=10	100=16
75=11	110=18
80=12	120=19

Needle Size for Fabrics

- 60 – very fine batiste
- 70 – shirt-weight
- 80 – medium-weight
- 90 – denim and twill
- 100/110/120 – canvas

General Information

Along with thread, needles are very important to stitch formation. Many "mechanical" problems and damage to fabrics can be traced to a bent, damaged, or incorrect size or type needle.

When selecting the correct needle, consider the following:

- Needle system – 130/705H
- Needle point – assures proper stitch formation; avoids fabric damage
- Needle size – smaller for lightweight fabrics; larger for heavier fabrics

If the needle is:

- Too small – the thread can't stay in the groove to form a loop to be picked up by the hook point
- Bent – the thread loop forms too far away from hook point and the hook can't enter the loop to form a stitch
- Blunt – the needle won't pierce fabric, so no thread loop forms to make a stitch

Need to Know

- Needles should be changed after every 8 hours of stitching, or earlier if stitches are looking bad. The needle is the most inexpensive part in your sewing machine, but it is crucial for getting good results and keeping your machine running well. Don't let false economy keep you from doing what is best for your sewing projects and your machine.
- The selected thread should fit in the groove on the front of the needle. If it isn't protected by the groove, a needle with a larger groove should be used.
- Always make sure needles are fully inserted as high as possible, with the flat side to the back.

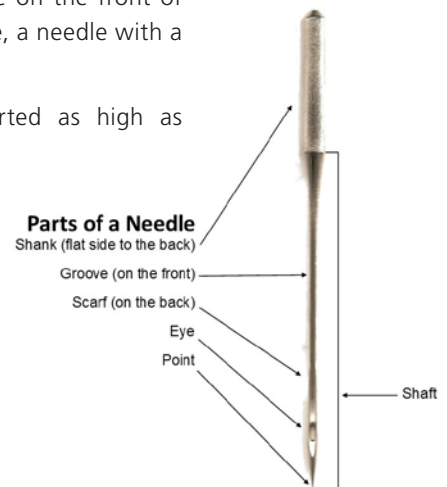

Sew HOW

Do you know how to:

- Use Creative Consultant for needle recommendations?

Utilize the needle minder?

REFERENCE - SEWING MACHINE NEEDLES

TYPE	SIZES	DESCRIPTION
Ballpoint	60 – 100	Has a rounded point. Size 70 for lingerie, nylon, jersey; 80 for t-shirt; 90 for sweatshirt fleece.
Stretch	70 – 90	A Stretch needle has a more rounded point than a Ballpoint, and a blue anti-cling coating which helps to prevent skipped stitches in knits and elastic. Sometimes used on Ultrasuede, vinyl, and plastic.
Universal	60 – 120	A compromise between a Sharp and a Ballpoint; used on both wovens and knits.
Double	1.6/70 – 8.0/100	Two needles attached to one shank. For pintucks, hems, and decorative work. Available in Universal, Stretch, Jeans, Metallic, and Embroidery needles.
Triple	2.5/90 – 3.0/90	Three needles attached to one shank. Used to create mock smocking and other decorative effects.
Jeans	70 – 110	Has a sharp point and a shaft that is less prone to flex. The sharpness of the needle is better for use on denim and woven fabrics.
Leather	80 – 100	Point is a sharp cutting wedge. Used for leather only. Not for vinyl or simulated leathers.
Microtex / Sharp	60 – 90	Sharp point; thin shaft. Specially designed for microfiber fabrics.
Quilting	75 and 90	Thin, tapered point eliminates potential damage to fabric when seaming and cross-seaming.
Topstitch	70 – 100	A sharp point with a large eye and deep groove. For use with heavier fabrics – the large groove cradles heavier threads.
Embroidery	75 and 90	Sharp needle with large eye and groove; has a coating and a larger scarf. Prevents shredding of rayon or metallic threads. Two threads may be used through the eye.
Metafil	80	Similar to Embroidery needle with large eye and deep groove. Made of a heat-resistant alloy with a friction-reducing coating. Suitable for manufactured fibers such as polyester, acrylic, and nylon.
Wing	100 and 110	Sharp-pointed needle with a non-cutting metal wedge on each side. Makes a hole without cutting the threads of the fabric. Used for decorative and heirloom work, such as hemstitching.
Double Wing	100	One Universal needle and one Wing needle attached to a single shank.
Metallic	70 – 100	Designed for metallic threads; has a large eye and deep groove.

REFERENCE - THREADS

To achieve quality stitches, a sewing machine needs three things: suitable thread, correct size needle, and properly adjusted thread tensions. Poor quality or the wrong type of thread can cause inferior stitches on any machine. Inferior thread results in crooked and looped stitches, puckered seams, frayed thread, and/or needle breakage. Did you know that thread passes through the eye of the needle approximately 37 times in a “seesaw” action before it forms a single stitch?

Long staple threads are stronger and smoother than short staple threads. (Staple refers to the length of fibers twisted together to form a single ply). Most bargain-priced threads are usually short staple and will deposit more lint and fuzz into your sewing machine, potentially causing tension inconsistencies and possibly even damage to your machine over the long term. Using long staple threads also result in less snagging and fraying as you sew.

Ply refers to the number of strands twisted together to make a single thread. The number of plies is usually indicated by a number after the weight of the thread such as 50/3, which means a 3-ply, 50-wt. thread. The lower the weight, the heavier the thread; conversely, higher numbers indicate fine or lightweight thread.

Guidelines for Thread Weights

- 12 wt.— Couching, bobbinwork
- 30 wt.— Embroidery, bobbinwork
- 40 wt.— General construction, quilting, embroidery
- 50 wt.— General construction, piecing, bobbin thread, quilting
- 60 wt.— Lingerie, heirloom, appliqué, bobbin thread, quilting
- 80 wt.— Extra-fine lingerie, heirloom

Fibers

Fiber refers to the type of material used to produce the thread.

Polyester

Good for clothing construction on man-made, natural or blended fabrics. Tolerates high temperatures. Polyester embroidery thread has a high sheen; excellent for embroidery, very abrasion resistant, and will not fade.

Cotton

Available in a wide range of weights from 12-100, cotton thread gives a soft, full look to embroidery, appliqué, and buttonholes. It is also excellent for clothing construction on natural fibers, patchwork piecing, darning, and heirloom sewing.

Rayon

A glossy embroidery thread, rayon is not as strong as cotton and polyester fibers, making it useful for decorative work, but not for construction techniques.

Silk

Used on silk and wool fabrics, this strong, lustrous fiber is good for construction and decorative details such as buttonholes. Also used for quilting as it blends into the fabric.



REFERENCE - DECORATIVE STITCHING

As you begin to experiment with decorative stitches on your BERNINA machine, there are several things you should keep in mind:

- Type of thread you plan to use
- Presser foot you select
- How you prepare your fabric

Type of Thread

Selecting the thread for decorative stitching often comes down to a personal preference and what looks best on your project.

Cotton embroidery thread, especially in a heavier weight such as 30, gives a beautiful look to the stitches and has a nice luster to it.

If you want a high sheen, rayon or polyester embroidery thread are good choices.

Preparing the fabric

Preparing your fabric correctly can take the frustration out of your stitching, giving you a positive experience with beautiful results. The fabric needs to be stable enough to support the stitching without tunneling or puckering. This can be accomplished in several ways, sometimes with a combination of techniques:

- The fabric itself might be heavy enough to support the stitching.
- Interfacing (fusible or sew-in) can be applied to the wrong side of the fabric and left in the project.
- Stabilizers are used as a temporary form of support.

For the exercises in this class, you will be using light-weight tear away stabilizer that can be removed after stitching if desired.

Presser Foot

The presser foot you select is critical for good results because it can affect the way the fabric feeds under the needle, influencing the stitch formation.

Usually the key to selecting the correct presser foot is the sole.

Stitches that are more open and have less thread will stitch well with an all-purpose or zigzag presser foot.

- Reverse Pattern Foot #1/1C/1D has small indentations in front of and behind the needle that allow the fabric to move in a “back and forth” manner when forming the stitches.

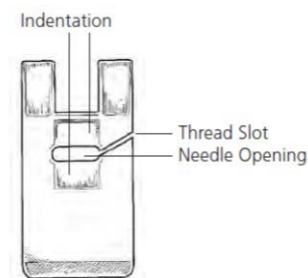

If you are creating heavy, satin stitched patterns, you will need a foot that is not flat on the bottom. It should have some type of indentation that allows the foot to ride over the completed stitch without dragging or inhibiting the feed of the fabric.

- Embroidery Foot #6 has a wedge-shaped indentation behind the needle, perfect for allowing heavy compact stitches to flow freely from under the back of the presser foot.

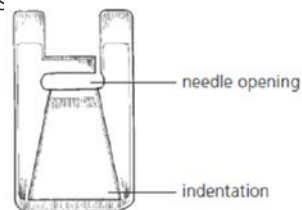

- Open Embroidery Foot #20/20C/20D and Clear Embroidery Foot #39/39C/39D both have the same shape but the Clear Embroidery Foot offers more visibility of the stitching area.

REFERENCE - CLEANING AND OILING

One of the most important parts of maintaining your machine is proper cleaning and oiling. Below are tips to follow, but more complete instructions for your specific model can be found in your machine's manual.

It is recommended that you clean and oil every other bobbin, or every 3-4 hours of actual sewing time. If you notice your machine sounding louder than usual, then it is time to clean and oil.

General Cleaning Steps

- Remove the needle. (It is recommended that you change your needle every 4-6 hours of sewing time.)
- Remove the stitch plate and remove all lint and threads, using the brush and/or the tweezers included with your machine.
- Clean the Thread Cutter (see below).
- Dust the lower thread indicator using the brush (on bobbin door).
- Remove the bobbin and clean and oil the bobbin area.



BERNINA has cleaning and oiling tutorials built into the Setup menu.

NOTE: *The B 435 has only an oiling tutorial.*

To access the tutorials, select the Setup icon >Machine Settings>Cleaning/Update.

Choose either the cleaning menu or the oiling menu and follow the steps shown. The menu may contain more than one page. Scroll with your fingertips or the stylus to access more information.

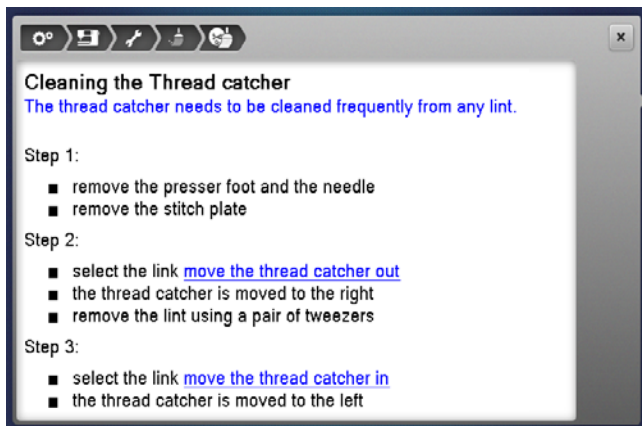

On those machines that have a Thread Cutter/Catcher, keeping the Thread Cutter clean and free of lint and thread tails is vital to the maintenance of the machine. The Thread Cutter needs to be cleaned frequently.

The Thread Cutter menu is interactive. Selecting the *move the thread catcher out* link on the screen will move the cutter to the right so that lint and threads can be removed with a pair of tweezers. Selecting the *move the thread catcher in* link returns the cutter to its normal position.

B 880 PLUS SEWING FUNCTIONS

External Buttons

1. Automatic Threading*
2. Securing Function
3. Needle Up/Down
4. Pattern End*
5. Presser Foot Up/Down
6. Auto Thread Cutter
7. Slide Speed Control
8. Start/Stop/Hover*
9. Backstepping/Quick Reverse



* Illuminated Buttons



SEWING FUNCTIONS							
	Programmable Pattern End		Programmable Foot Control		Combi-Mode		Pattern Repeat
	Upper Thread Tension		Needle Stop Up/Down-Permanent		Overview Combi-Mode		Mirror Image Left/Right
	Needle Security		Fit to Screen		Edit the Complete Combination		Mirror Image Up/Down
	Needle minder		Information i-dialog		Edit Combination at Cursor Position		Balance
	Presser Foot Indicator/Presser Foot Selection		Stitch Selection by Number		Combination Sub-divider (1)		Pattern Extend Adjust Stitch Density
	Presser Foot Pressure		Practical Stitches		Combination Sub-divider (2)		Stitch Density
	Stitch Plate Security		Decorative Stitches		Retrieve Saved Stitch		Font Size in Alphabet
	Feed Dog Indicator Up/Down		Alphabets		Retrieve Combination		Monogram Size
	Bobbin Filling with Low Level Status Indicator		Buttonholes		Save to Personal Program		Long Stitch
	Clock/Alarm		Quilting Stitches		Delete from Personal Program		Multi-directional Sewing
	Home		Personal Program		Direct Entry Buttonhole with Length		Distortion
	Setup		History Stitches		Program Buttonhole Length		Tapering
	Tutorial		Stitch Designer		Stitch Counter Buttonhole		Save Stitch Settings
	Creative Consultant		Triple Stitch-Stitch Designer		Manual Buttonhole		Restore Stitch Default
	Help (Press long for slide show)		Move Needlepoint Stitch Designer		Buttonhole Slit Width		Continuous Reverse
	Eco		Undo/Redo Stitch Designer		Stitch Counter		Backstepping
	Clear - Back to Basic Setting		Duplicate Stitch Designer		Use Upper Multifunction Knob for Adjustment		Delete
			Snap to Grid		Use Lower Multifunction Knob for Adjustment		Confirm
			New/Clean Screen Stitch Designer		Use Either Multifunction Knob for Adjustment		Escape
			Stitch Playback Stitch Designer				Close / Cancel

B 790 PLUS SEWING FUNCTIONS

External Buttons

1. Start/Stop
2. Presser Foot Up/Down
3. Auto Thread Cutter
4. Quick Reverse





SEWING FUNCTIONS							
	Move Needle Up/Down		Programmable Foot Control		Combi-Mode		Pattern Repeat
	Pattern Begin (External Button)		Needle Stop Up/Down-Permanent		Overview Combi-Mode		Mirror Image Left/Right
	Securing		Fit to Screen		Edit the Complete Combination		Mirror Image Up/Down
	Programmable Pattern End		Information i-dialog		Edit Combination at Cursor Position		Balance
	Upper Thread Tension		Stitch Selection by Number		Combination Sub-divider (1)		Pattern Extend
	Needle Security		Practical Stitches		Combination Sub-divider (2)		Pattern Extend Adjust Stitch Density
	Needleminder		Decorative Stitches		Retrieve Saved Stitch		Font Size in Alphabet
	Presser Foot Indicator/Presser Foot Selection		Alphabets		Retrieve Combination		Monogram Size
	Presser Foot Pressure		Buttonholes		Save to Personal Program		Long Stitch
	Stitch Plate Security		Quilting Stitches		Delete from Personal Program		Multi-directional Sewing
	Feed Dog Indicator Up/Down		Personal Program		Direct Entry Buttonhole with Length		Tapering
	Bobbin Filling with Low Level Status Indicator		History Stitches		Program Buttonhole Length		Save Stitch Settings
	Home		Stitch Designer		Stitch Counter Buttonhole		Restore Stitch Default
	Setup		Triple Stitch-Stitch Designer		Manual Buttonhole		Continuous Reverse
	Tutorial		Move Needlepoint Stitch Designer		Buttonhole Slit Width		Backstepping
	Creative Consultant		Undo/Redo Stitch Designer		Stitch Counter		Delete
	Help (Press long for slide show)		Duplicate Stitch Designer		Use Upper Multifunction Knob for Adjustment		Confirm
	Eco		Snap to Grid		Use Lower Multifunction Knob for Adjustment		Escape
	Clear - Back to Basic Setting		New/Clean Screen Stitch Designer		Use Either Multifunction Knob for Adjustment		Close / Cancel
			Stitch Playback Stitch Designer				

B 770 QE SEWING FUNCTIONS

External Buttons

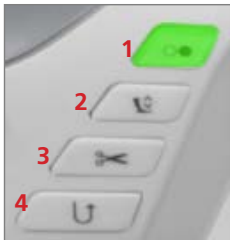
1. Start/Stop
2. Presser Foot
3. Up/Down
4. Auto Thread Cutter
5. Quick Reverse



SEWING FUNCTIONS							
	Move Needle Up/Down		Programmable Foot Control		Retrieve Saved Stitch		Pattern Extend Adjust Stitch Density
	Programmable Pattern End		Needle Stop Up/Down-Permanent		Retrieve Combination		Font Size in Alphabet
	Pattern Begin		Information i-dialog		Save to Personal Program		Long Stitch
	Upper Thread Tension		Stitch Selection by Number		Delete from Personal Program		Continuous Reverse
	Presser Foot Indicator/ Presser Foot Selection		Practical Stitches		Direct Entry Buttonhole with Length		Backstepping
	Presser Foot Pressure		Decorative Stitches		Program Buttonhole Length		Save Stitch Settings
	Stitch Plate Security/ Needle Plate Security		Alphabets		Stitch Counter Buttonhole		Restore Stitch Default
	Needle minder		Buttonholes		Manual Buttonhole		Delete
	Feed Dog Indicator Up/Down		Quilting Stitches		Buttonhole Slit Width		Confirm
	Bobbin Filling with Low Level Status Indicator		Personal Program		Stitch Counter		Escape
	Home		Combi-Mode		Securing		Close / Cancel
	Setup		Edit the Complete Combination		Pattern Repeat		Use Upper Multifunction Knob for Adjustment
	Tutorial		Edit Combination at Cursor Position		Mirror Image Left/Right		Use Lower Multifunction Knob for Adjustment
	Creative Consultant		Combination Sub-divider (1)		Mirror Image Up/Down		Use Either Multifunction Knob for Adjustment
	Help		Combination Sub-divider (2)		Balance		
	Eco (Press long for slide show)				Pattern Extend		
	Clear - Back to Basic Setting						

B 740 SEWING FUNCTIONS

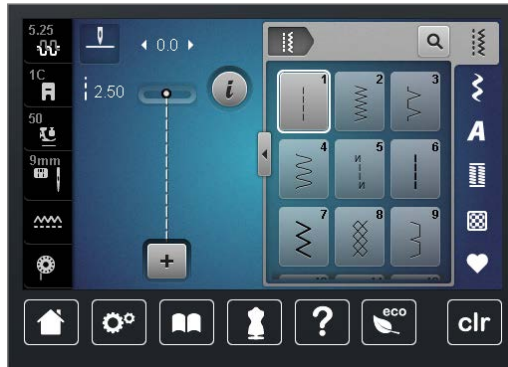
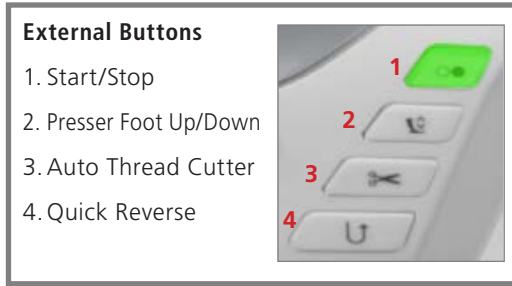

SEWING FUNCTIONS							
	Move Needle Up/Down		Programmable Foot Control		Retrieve Saved Stitch		Pattern Extend
	Pattern Begin		Needle Stop Up/Down-Permanent		Retrieve Combination		Pattern Extend Adjust Stitch Density
	Programmable Pattern End		Information i-dialog		Save to Personal Program		Font Size in Alphabet
	Upper Thread Tension		Stitch Selection by Number		Delete from Personal Program		Continuous Reverse
	Presser Foot Indicator/ Presser Foot Selection		Practical Stitches		Direct Entry Buttonhole with Length		Backstepping
	Presser Foot Pressure		Decorative Stitches		Program Buttonhole Length		Save Stitch Settings
	Stitch Plate Security/ Needle Plate Security		Alphabets		Stitch Counter Buttonhole		Restore Stitch Default
	Needle minder		Buttonholes		Manual Buttonhole		Delete
	Feed Dog Indicator Up/Down		Quilting Stitches		Buttonhole Slit Width		Confirm
	Bobbin Filling with Low Level Status Indicator		Personal Program		Stitch Counter		Escape
	Home		Combi-Mode		Securing		Close / Cancel
	Setup		Edit the Complete Combination		Pattern Repeat		Use Upper Multifunction Knob for Adjustment
	Tutorial		Edit Combination at Cursor Position		Mirror Image Left/Right		Use Lower Multifunction Knob for Adjustment
	Creative Consultant		Combination Sub-divider (1)		Mirror Image Up/Down		Use Either Multifunction Knob for Adjustment
	Help		Combination Sub-divider (2)		Balance		
	Eco (Press long for slide show)						
	Clear - Back to Basic Setting						

B 590 SEWING FUNCTIONS

External Buttons

1. Start/Stop
2. Presser Foot
3. Up/Down
4. Auto Thread Cutter
5. Quick Reverse





SEWING FUNCTIONS							
	Move Needle Up/Down		Programmable Foot Control		Retrieve Saved Stitch		Pattern Extend
	Programmable Pattern End		Needle Stop Up/Down-Permanent		Retrieve Combination		Pattern Extend Adjust Stitch Density
	Pattern Begin		Information i-dialog		Save to Personal Program		Font Size in Alphabet
	Upper Thread Tension		Stitch Selection by Number		Delete from Personal Program		Long Stitch
	Presser Foot Indicator/Presser Foot Selection		Practical Stitches		Direct Entry Buttonhole with Length		Triple Stitch
	Presser Foot Pressure		Decorative Stitches		Program Buttonhole Length		Continuous Reverse
	Stitch Plate Security/Needle Plate Security		Alphabets		Stitch Counter Buttonhole		Backstepping
	Needle minder		Buttonholes		Manual Buttonhole		Save Stitch Settings
	Feed Dog Indicator Up/Down		Quilting Stitches		Buttonhole Slit Width		Restore Stitch Default
	Bobbin Filling with Low Level Status Indicator		Personal Program		Stitch Counter		Delete
	Home		Combi-Mode		Securing		Confirm
	Setup		Edit the Complete Combination		Pattern Repeat		Escape
	Tutorial		Edit Combination at Cursor Position		Mirror Image Left/Right		Close / Cancel
	Creative Consultant		Combination Sub-divider (1)		Mirror Image Up/Down		Use Upper Multifunction Knob for Adjustment
	Help		Combination Sub-divider (2)		Balance		Use Lower Multifunction Knob for Adjustment
	Eco						Use Either Multifunction Knob for Adjustment
	Clear - Back to Basic Setting						

B 570 QE SEWING FUNCTIONS

External Buttons

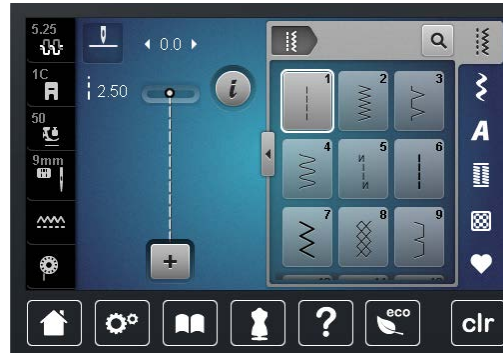
1. Start/Stop
2. Securing Function
3. Auto Thread Cutter
4. Quick Reverse

SEWING FUNCTIONS

	Move Needle Up/Down		Programmable Foot Control		Retrieve Saved Stitch		Pattern Extend
	Programmable Pattern End		Needle Stop Up/Down-Permanent		Retrieve Combination		Pattern Extend Adjust Stitch Density
	Pattern Begin		Information i-dialog		Save to Personal Program		Font Size in Alphabet
	Upper Thread Tension		Stitch Selection by Number		Delete from Personal Program		Long Stitch
	Presser Foot Indicator/Presser Foot Selection		Practical Stitches		Direct Entry Buttonhole with Length		Triple Stitch
	Presser Foot Pressure		Decorative Stitches		Program Buttonhole Length		Continuous Reverse
	Stitch Plate Security/Needle Plate Security		Alphabets		Stitch Counter Buttonhole		Backstepping
	Needle minder		Buttonholes		Manual Buttonhole		Save Stitch Settings
	Feed Dog Indicator Up/Down		Quilting Stitches		Buttonhole Slit Width		Restore Stitch Default
	Bobbin Filling with Low Level Status Indicator		Personal Program		Stitch Counter		Delete
	Home		Combi-Mode		Securing		Confirm
	Setup		Edit the Complete Combination		Pattern Repeat		Escape
	Tutorial		Edit Combination at Cursor Position		Mirror Image Left/Right		Close / Cancel
	Creative Consultant		Combination Sub-divider (1)		Mirror Image Up/Down		Use Upper Multifunction Knob for Adjustment
	Help		Combination Sub-divider (2)		Balance		Use Lower Multifunction Knob for Adjustment
	Eco						Use Either Multifunction Knob for Adjustment
	Clear - Back to Basic Setting						

B 535 SEWING FUNCTIONS

External Buttons

1. Start/Stop
2. Securing Function
3. Auto Thread Cutter
4. Quick Reverse

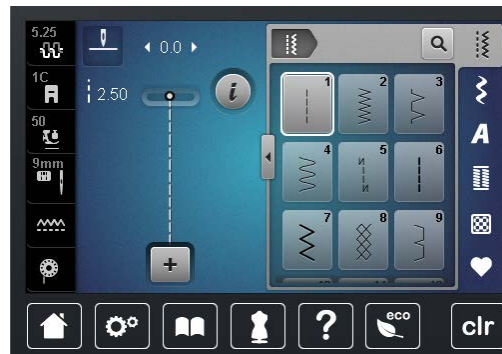



SEWING FUNCTIONS							
	Move Needle Up/Down		Needle Stop Up/Down-Permanent		Retrieve Saved Stitch		Pattern Extend
	Pattern End		Information i-dialog		Retrieve Combination		Pattern Extend Adjust Stitch Density
	Pattern Begin		Stitch Selection by Number		Save to Personal Program		Font Size in Alphabet
	Upper Thread Tension		Practical Stitches		Delete from Personal Program		Long Stitch
	Presser Foot Indicator/Presser Foot Selection		Decorative Stitches		Direct Entry Buttonhole with Length		Triple Stitch
	Presser Foot Pressure (Manual)		Alphabets		Program Buttonhole Length		Continuous Reverse
	Stitch Plate Security/Needle Plate Security		Buttonholes		Stitch Counter Buttonhole		Backstepping
	Needle minder		Quilting Stitches		Manual Buttonhole		Save Stitch Settings
	Feed Dog Indicator Up/Down		Personal Program		Buttonhole Slit Width		Restore Stitch Default
	Bobbin Filling with Low Level Status Indicator		Combi-Mode		Stitch Counter		Delete
	Home		Edit the Complete Combination		Securing		Confirm
	Setup		Edit Combination at Cursor Position		Pattern Repeat		Escape
	Tutorial		Combination Sub-divider (1)		Mirror Image Left/Right		Close / Cancel
	Creative Consultant		Combination Sub-divider (2)		Mirror Image Up/Down		Use Upper Multifunction Knob for Adjustment
	Help				Balance		Use Lower Multifunction Knob for Adjustment
	Eco						Use Either Multifunction Knob for Adjustment
	Clear - Back to Basic Setting						

B 480 SEWING FUNCTIONS

External Buttons

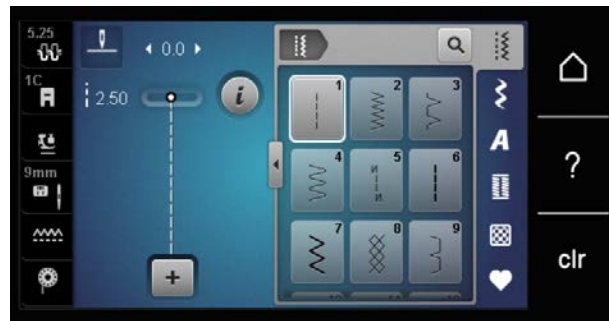
1. Start/Stop
2. Securing Function
3. Auto Thread Cutter
4. Quick Reverse

SEWING FUNCTIONS

	Move Needle Up/Down		Programmable Foot Control		Retrieve Saved Stitch		Pattern Extend
	Pattern End		Needle Stop Up/Down-Permanent		Retrieve Combination		Continuous Reverse
	Pattern Begin		Information i-dialog		Save to Personal Program		Save Stitch Settings
	Upper Thread Tension		Stitch Selection by Number		Delete from Personal Program		Restore Stitch Default
	Presser Foot Indicator/ Presser Foot Selection		Practical Stitches		Direct Entry Buttonhole with Length		Delete
	Presser Foot Pressure (Manual)		Decorative Stitches		Program Buttonhole Length		Confirm
	Stitch Plate Security/ Needle Plate Security		Alphabets		Stitch Counter Buttonhole		Escape
	Needle minder		Buttonholes		Manual Buttonhole		Close / Cancel
	Feed Dog Indicator Up/Down		Quilting Stitches		Buttonhole Slit Width		Use Upper Multifunction Knob for Adjustment
	Bobbin Filling with Low Level Status Indicator		Personal Program		Stitch Counter		Use Lower Multifunction Knob for Adjustment
	Home		Combi-Mode		Pattern Repeat		Use Either Multifunction Knob for Adjustment
	Setup		Edit the Complete Combination		Mirror Image Left/Right		
	Tutorial		Edit Combination at Cursor Position		Mirror Image Up/Down		
	Creative Consultant				Balance		
	Help						
	Eco						
	Clear - Back to Basic Setting						

B 475 QE SEWING FUNCTIONS

External Buttons

1. Start/Stop
2. Securing Function
3. Auto Thread Cutter
4. Quick Reverse

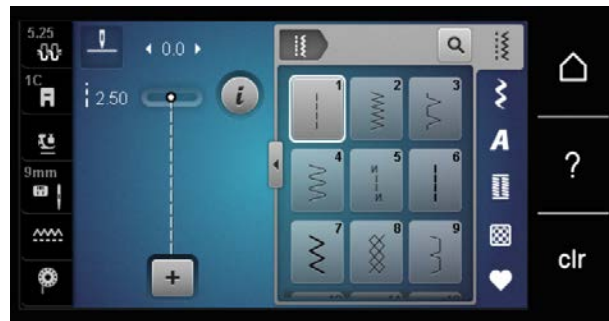



SEWING FUNCTIONS							
	Move Needle Up/Down		Needle Stop Up/Down-Permanent		Retrieve Saved Stitch		Continuous Reverse
	Pattern End		Information i-dialog		Retrieve Combination		Save Stitch Settings
	Pattern Begin		Stitch Selection by Number		Save to Personal Program		Restore Stitch Default
	Upper Thread Tension		Practical Stitches		Delete from Personal Program		Delete
	Presser Foot Indicator/ Presser Foot Selection		Decorative Stitches		Direct Entry Buttonhole with Length		Confirm
	Presser Foot Pressure (Manual)		Alphabets		Program Buttonhole Length		Escape
	Stitch Plate Security/ Needle Plate Security		Buttonholes		Stitch Counter Buttonhole		Close / Cancel
	Needleminder		Quilting Stitches		Manual Buttonhole		Use Upper Multifunction Knob for Adjustment
	Feed Dog Indicator Up/Down		Personal Program		Stitch Counter		Use Lower Multifunction Knob for Adjustment
	Bobbin Filling with Low Level Status Indicator		Combi-Mode		Pattern Repeat		Use Either Multifunction Knob for Adjustment
	Home		Edit the Complete Combination		Mirror Image Left/Right		
	Setup		Edit Combination at Cursor Position		Mirror Image Up/Down		
	Tutorial				Balance		
	Creative Consultant						
	Help						
	Eco						
	Clear - Back to Basic Setting						

B 435 SEWING FUNCTIONS

External Buttons

1. Start/Stop
2. Securing Function
3. Quick Reverse



SEWING FUNCTIONS							
	Move Needle Up/Down		Needle Stop Up/Down-Permanent		Retrieve Saved Stitch		Continuous Reverse
	Pattern End		Information i-dialog		Retrieve Combination		Delete
	Pattern Begin		Stitch Selection by Number		Save to Personal Program		Confirm
	Upper Thread Tension		Practical Stitches		Delete from Personal Program		Escape
	Presser Foot Indicator/ Presser Foot Selection		Decorative Stitches		Direct Entry Buttonhole with Length		Close / Cancel
	Presser Foot Pressure (Manual)		Alphabets		Program Buttonhole Length		Use Upper Multifunction Knob for Adjustment
	Stitch Plate Security/ Needle Plate Security		Buttonholes		Stitch Counter Buttonhole		Use Lower Multifunction Knob for Adjustment
	Needleminder		Quilting Stitches		Manual Buttonhole		Use Either Multifunction Knob for Adjustment
	Feed Dog Indicator Up/Down		Personal Program		Stitch Counter		
	Bobbin Filling with Low Level Status Indicator		Combi-Mode		Pattern Repeat		
	Home		Edit the Complete Combination		Mirror Image Left/Right		
	Setup		Edit Combination at Cursor Position		Mirror Image Up/Down		
	Tutorial				Balance		
	Creative Consultant						
	Help						
	Eco						
	Clear - Back to Basic Setting						